

## Cutting

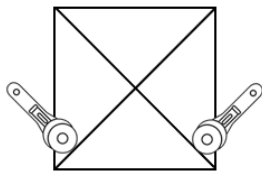
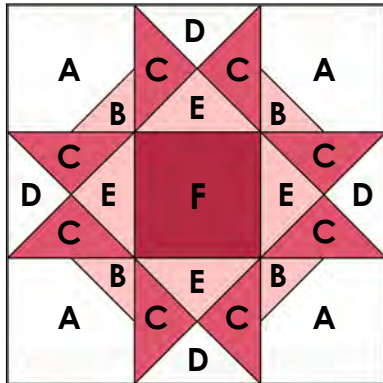

Cut Square Twice Diagonally

<b>A</b>	Cut (4) 4 ½" squares. <i>Grunge #30150- 101</i>
<b>B</b>	(4) 2 ½" squares; draw a diagonal line from corner to corner on the wrong side of each square. <i>Grunge #30150- 64</i>
<b>C</b>	Cut (2) 5 ¼" squares; cut each square twice diagonally from corner to corner to make (8) C triangles. <i>Grunge #30150- 327</i>
<b>D</b>	Cut (1) 5 ¼" square; cut the square twice diagonally from corner to corner to make (4) D triangles. <i>Grunge #30150-101</i>
<b>E</b>	Cut (1) 5 ¼" square; cut the square twice diagonally from corner to corner to make (4) E triangles. <i>Grunge #30150- 64</i>
<b>F</b>	(1) 4 ½" square. <i>Grunge #30150- 327</i>

## Assembly

1. Begin making the block corner units using stitch and flip methods. Place (1) B square with a drawn diagonal line onto the corner of (1) A square, right sides together and edges aligned.
2. Sew along the drawn line.
3. Trim outermost excess fabric to ¼" and press to the corner.
4. Repeat to make (4) stitch and flip block corner units measuring 4 ½" x 4 ½" unfinished.
5. Begin making QST units by laying out (2) C triangles and (1) D and E triangle as shown. C triangles should be opposite one another, and D and E triangles should be opposite one another.
6. Sew together as shown, pressing toward the C triangles.
7. Sew the halves together to complete the QST unit. Press.
8. Repeat to make (4) identical QST units measuring 4 ½" x 4 ½" unfinished.

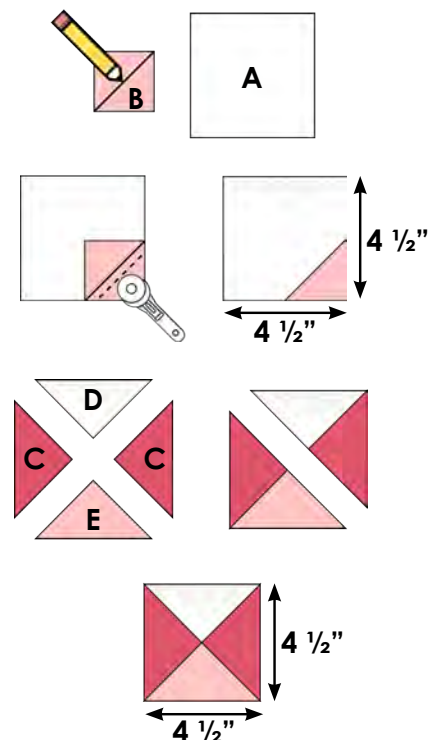

9. Begin block assembly by laying out (4) block corner units, (4) QST units and (1) F square as shown. Ensure that stitch and flip units and QST units are oriented correctly.

10. Sew together in rows, pressing away from the QST units.

11. Sew rows together to complete the block. Block should measure 12 1/2" x 12 1/2" unfinished.



Block 1  
Underdog

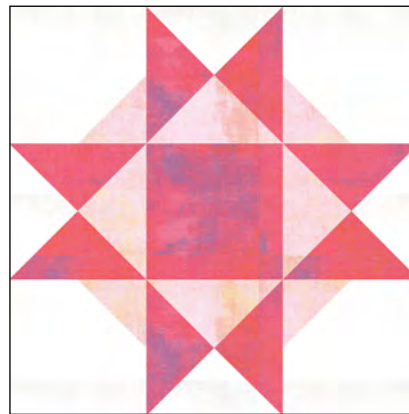
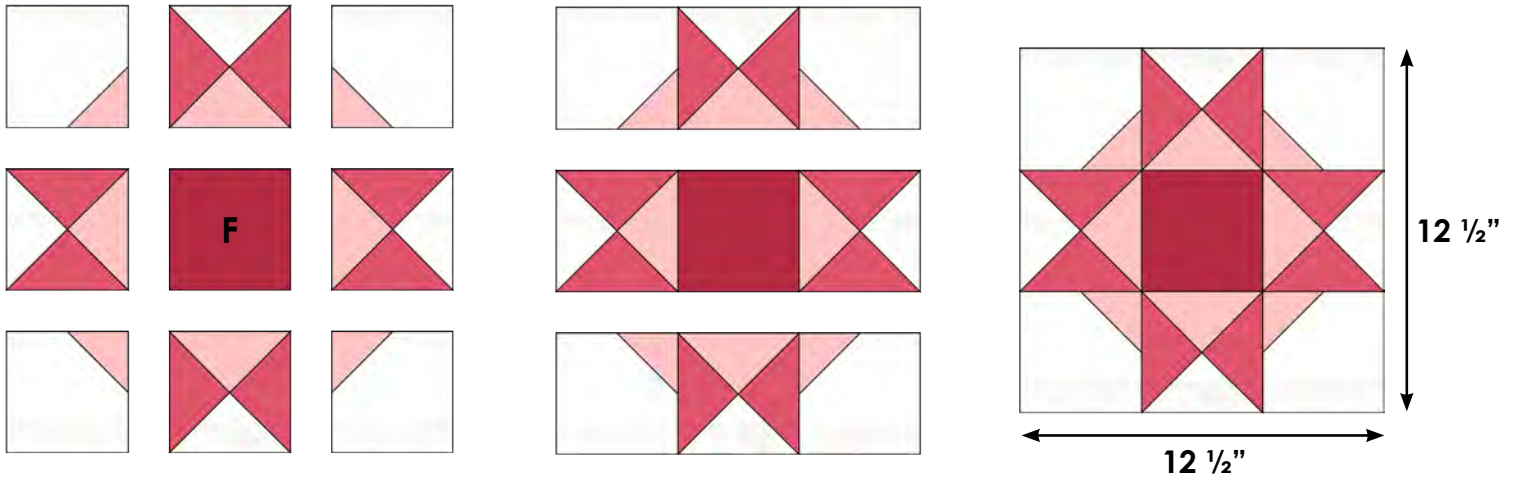

*Be sure to share your block and progress online!*

**#ModaStitchPink**



## Cutting

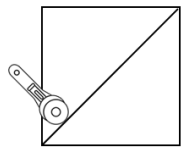
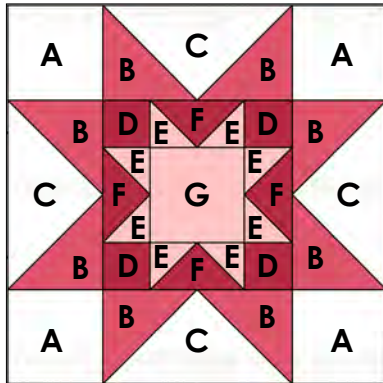

Cut Square Once Diagonally

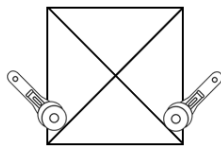

Cut Square Twice Diagonally

<b>A</b>	(4) 3 1/2" squares. <i>Grunge #30150 101</i>
<b>B</b>	(4) 3 7/8" squares; cut each square once diagonally to make (8) B triangles. <i>Grunge #30150 325</i>
<b>C</b>	(1) 7 1/4" square; cut the square twice diagonally to make (4) C triangles. <i>Grunge #30150 101</i>
<b>D</b>	(4) 2" squares. <i>Grunge #30150 253</i>
<b>E</b>	(4) 2 3/8" squares; cut each square once diagonally to make (8) E triangles. <i>Grunge #30150 64</i>
<b>F</b>	(1) 4 1/4" square; cut the square twice diagonally to make (4) F triangles. <i>Grunge #30150 253</i>
<b>G</b>	(1) 3 1/2" square. <i>Grunge #30150 64</i>

## Assembly

- Both small and large flying geese units are needed to create this block. Begin large flying geese unit assembly by placing (1) B triangle on either side of (1) C triangle as shown.
- Sew the B triangles to the C triangle one at a time using a scant 1/4" seam. Press toward the corners.
- Trim large flying geese units to measure 3 1/2" x 6 1/2" unfinished. Repeat to make (4) identical large flying geese units.

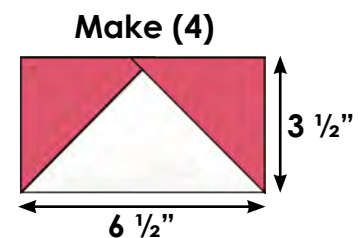
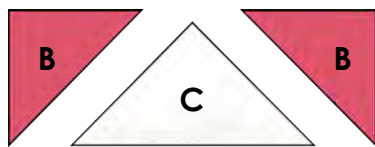

- Repeat flying geese unit assembly techniques to make small flying geese units. Gather (8) E triangles and (4) F triangles to make (4) identical small flying geese units measuring 2" x 3 1/2" unfinished.

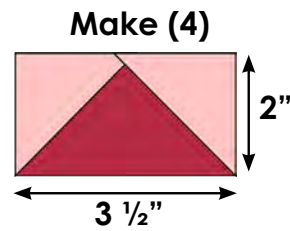
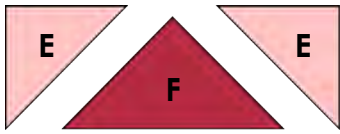

Block 2  
On the Rise

- Complete the block center star using (4) small flying geese units, (4) D squares and (1) G square. For all seams, press to the plain squares and away from the flying geese units.
- Once complete, the block center star should measure 6 1/2" x 6 1/2" unfinished.

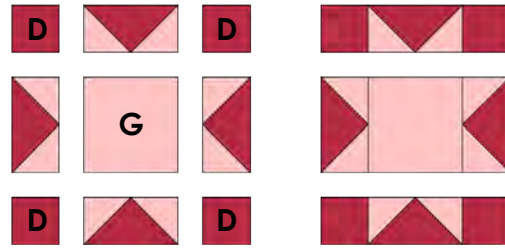

- Complete the block using the block center star, (4) large flying geese units and (4) A squares. Sew together in rows. For all seams, press toward the block center star and the A squares.
- Sew rows together to complete the block. Block should measure 12 1/2" x 12 1/2" unfinished.

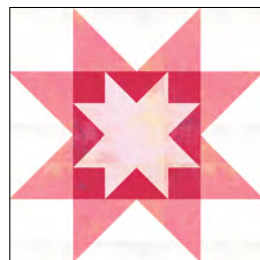
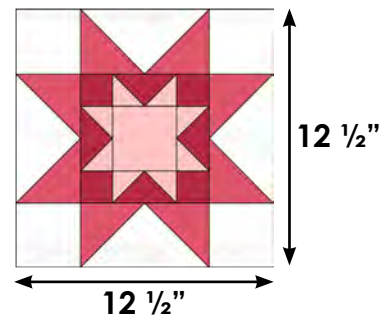
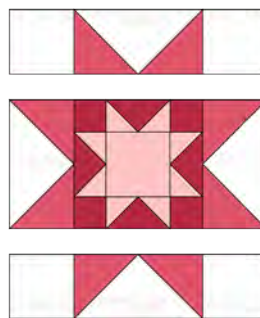
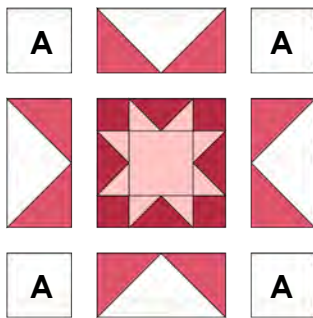

Be sure to share your block and progress online!

#ModaStitchPink



To make best use of fabric, cut a 7" strip of color #377 and set aside for block 19 or else you will not have a big enough piece to cut from.

## Cutting

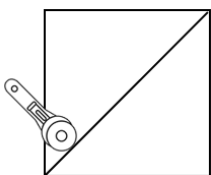
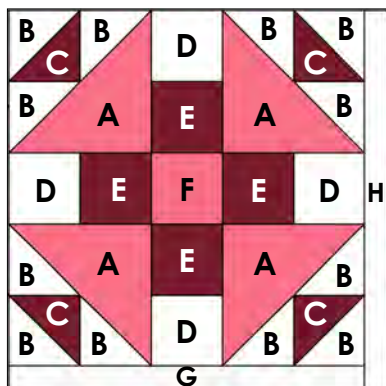

Cut Square Once Diagonally

<b>A</b>	<u>SEE NOTE ABOVE BEFORE CUTTING</u> (2) 5 3/8" squares; cut each square once diagonally to make (4) A triangles. <i>Grunge #30150 377</i>
<b>B</b>	(6) 3 1/8" squares; cut each square once diagonally to make (12) B triangles. <i>Grunge #30150 101</i>
<b>C</b>	(2) 3 1/8" squares; cut each square once diagonally to make (4) C triangles. <i>Grunge #30150 82</i>
<b>D</b>	(4) 2 3/4" squares. <i>Grunge #30150 101</i>
<b>E</b>	(4) 2 3/4" squares. <i>Grunge #30150 82</i>
<b>F</b>	(1) 2 3/4" square. <i>Grunge #30150 377</i>
<b>G</b>	(1) 1 1/4" x 11 3/4" rectangle. <i>Grunge #30150 101</i>
<b>H</b>	(1) 1 1/4" x 12 1/2" rectangle. <i>Grunge #30150 101</i>

## Assembly

1. Begin HST unit assembly by placing (1) B triangle and (1) C triangle right sides together and edges aligned.
2. Sew along the longest edge using a 1/4" seam.
3. Trim HST unit to measure 2 3/4" x 2 3/4" unfinished. Press toward the dark fabric.
4. Repeat to make (4) identical HST units.
5. Lay out (1) HST unit, (2) B triangles and (1) A triangle as shown in the diagram.
6. Sew both B triangles to the HST unit. Press toward both B triangles.
7. Sew the longest edge of the A triangle to the unit created in Step 6. Press toward the A triangle.
8. Repeat to make (4) identical block corner units. Trim block corner units to measure 5" x 5" unfinished.

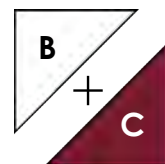

Make (4)

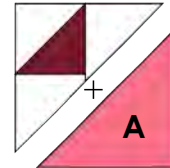
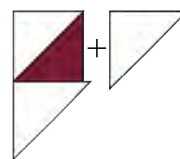
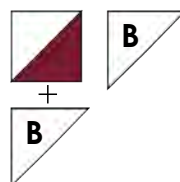
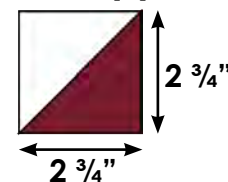

Make (4)

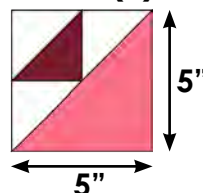



Block 3

Monkeying Around

- Lay out (4) block corner units, (4) D squares, (4) E squares and (1) F square as shown. Sew together in (3) horizontal rows. Arrows indicate pressing instructions. Diagrams show the block in all stages of assembly.
- Sew the horizontal rows together. Block should measure  $11 \frac{3}{4}$ " x  $11 \frac{3}{4}$ " unfinished at this step.

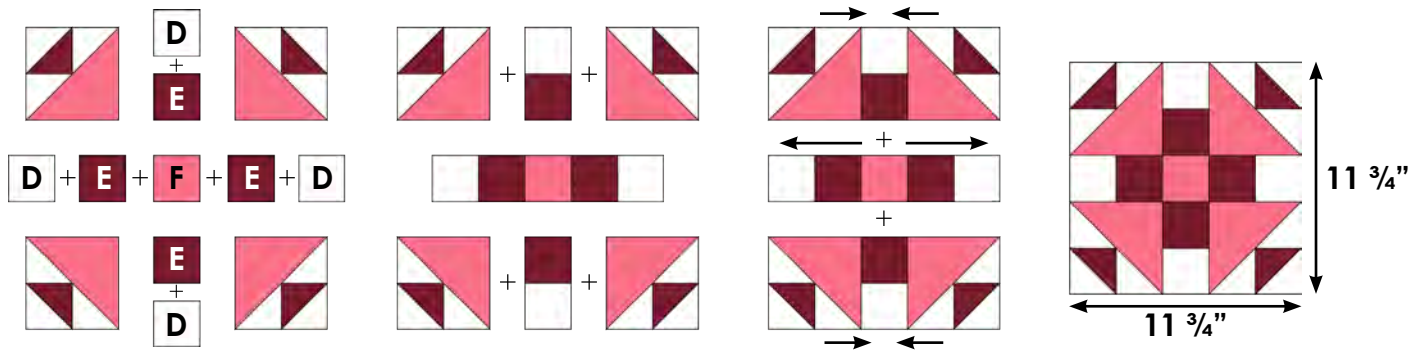

- Continue block assembly by sewing (1) G rectangle to the bottom of the block, press toward the rectangle.
- Complete block assembly by sewing (1) H rectangle to the right side of the block, press toward the rectangle. Completed block should measure  $12 \frac{1}{2}$ " x  $12 \frac{1}{2}$ " unfinished.

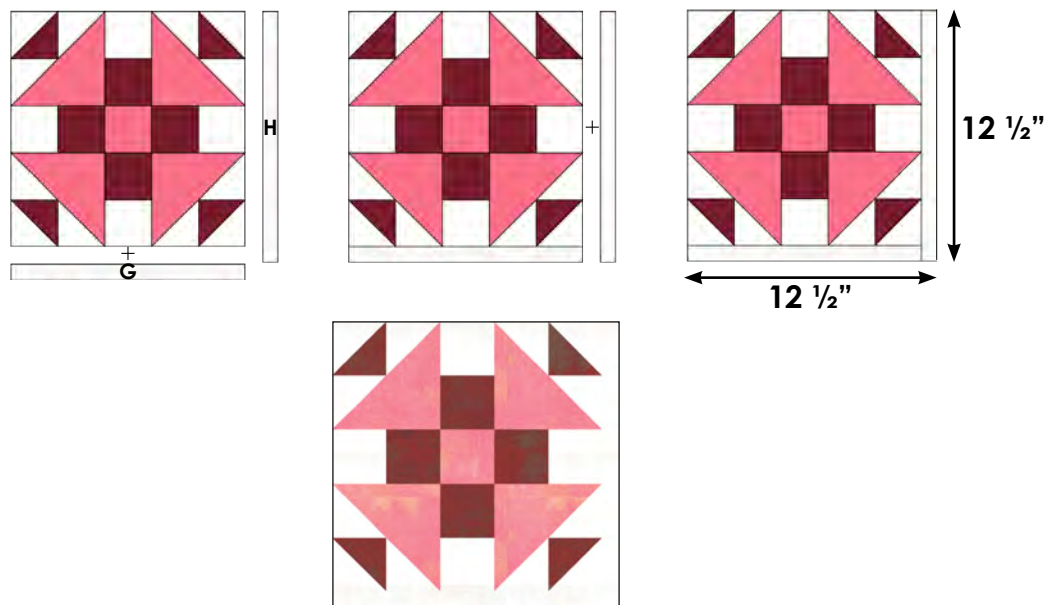

Be sure to share your block and progress online!

#ModaStitchPink



**PLEASE NOTE:** B triangles are shown using (2) fabrics. Adjust cutting according to quantity of fabrics you wish to use.

## Cutting

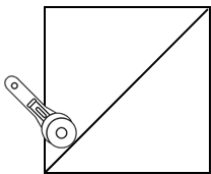
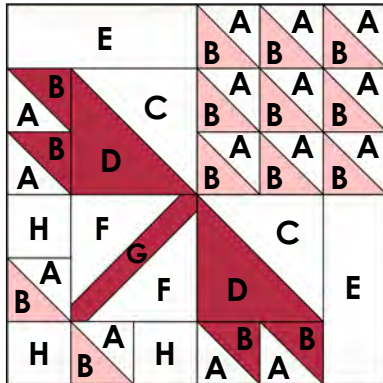

Cut Square Once Diagonally

<b>A</b>	(8) 2 7/8" squares; cut each square once diagonally to make (16) A triangles. Please note: (1) triangle will be unused. <i>Grunge #30150 101</i>
<b>B</b>	(8) 2 7/8" squares; cut each square once diagonally to make (16) B triangles. (1) triangle will be unused. <i>Grunge-6 from 325 &amp; 2 from 365</i>
<b>C</b>	(1) 4 7/8" square; cut the square once diagonally to make (2) C triangles. <i>Grunge #30150 101</i>
<b>D</b>	(1) 4 7/8" square; cut the square once diagonally to make (2) D triangles. <i>Grunge #30150 365</i>
<b>E</b>	Cut (2) 2 1/2" x 6 1/2" rectangles. <i>Grunge #30150 101</i>
<b>F</b>	(1) 4 1/2" square; cut once diagonally to make (2) F triangles. <i>Grunge #30150 101</i>
<b>G</b>	(1) 1" x 6 1/2" rectangle. <i>Grunge #30150 365</i>
<b>H</b>	(3) 2 1/2" squares. <i>Grunge #30150 101</i>

## Assembly

- Both small and large HST units are needed to create this block. Begin large HST unit assembly by placing (1) C triangle and (1) D triangle right sides together and edges aligned.
- Sew along the longest edge using a 1/4" seam.
- Trim HST unit to measure 4 1/2" x 4 1/2" unfinished. Press toward the dark fabric.
- Repeat to create (2) identical large HST units.
- Begin small HST unit assembly using the same techniques described above and (15) A and B triangles. (Please note: Diagrams and quilt block is shown using (2) small HST unit colorways.)
- Trim small HST units to measure 2 1/2" x 2 1/2" unfinished.

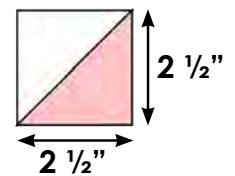
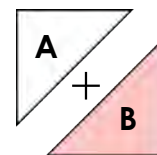
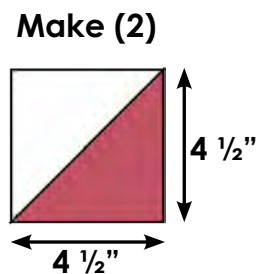
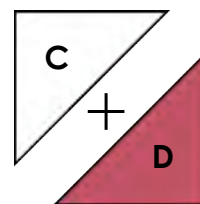

**Make (11)**

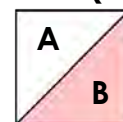

**Make (4)**

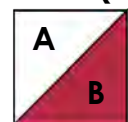

7. Create the block stem using (1) G rectangle and (2) F triangles. Begin by pressing the F triangles and the G rectangle in half to mark the exact centers with a crease.
8. Line up the creased centers and sew (1) F triangle onto either side of the G rectangle.
9. Press triangles away from the G rectangle.
10. Remove excess fabric, trimming the stem to measure 4 1/2" x 4 1/2" unfinished.

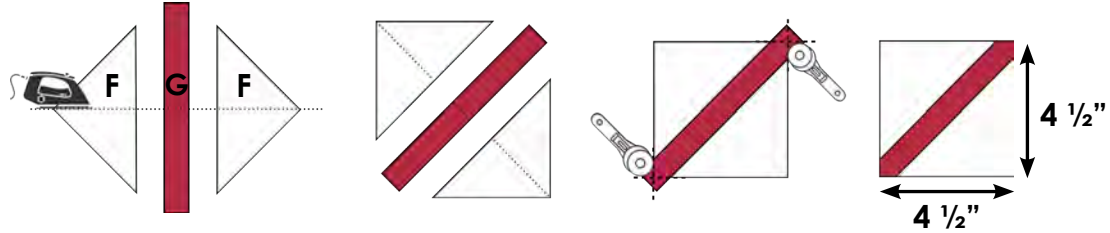

11. Lay out all units created in the above steps, (2) E rectangles and (3) H squares as shown. Sew the block together in quadrants. Arrows indicate pressing instructions.
12. Sew the quadrants together to complete the block. Press to complete. Block should measure 12 1/2" x 12 1/2" unfinished.

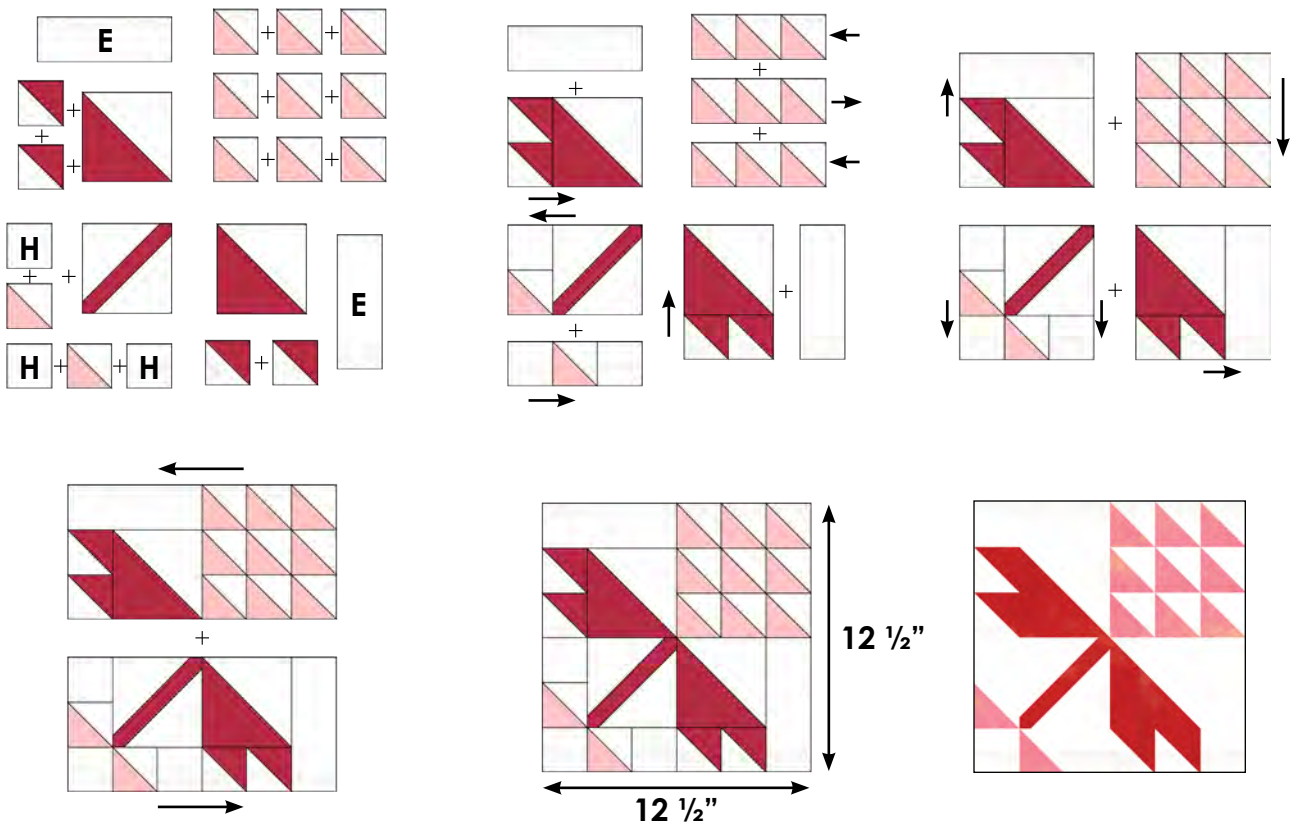

*Be sure to share your block and progress online!*

**#ModaStitchPink**





PLEASE NOTE: B triangles are shown using (2) fabrics. Adjust cutting according to quantity of fabrics you wish to use.

## Cutting

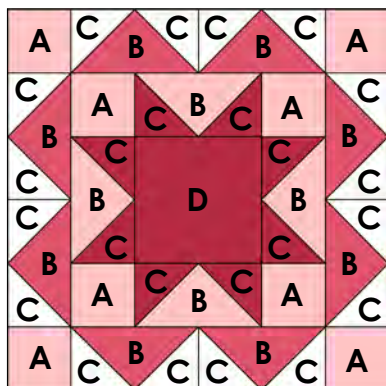

**PLEASE NOTE:** Flying Geese Units in the Block #5 Pattern are shown in two colorways. You may opt to create only one colorway of flying geese unit, or two. Plan your fabric placement before cutting, then cut according to the quantity of fabrics you wish to use.

<b>A</b>	(8) 2 1/2" squares. <i>Grunge #30150 64</i>
<b>B</b>	(3) 5 1/4" squares; cut each square twice diagonally to make (12) B triangles. <i>Grunge 1-64 &amp; 2-332</i>
<b>C</b>	(12) 2 7/8" squares; cut each square once diagonally to make (24) C triangles. <i>Grunge cut 8-101 &amp; 4-332</i>
<b>D</b>	Cut (1) 4 1/2" square. <i>Grunge #30150 332</i>

## Assembly

**PLEASE NOTE:** Flying geese units are shown in two colorways. Both colorways are the same size. Use the following instructions to make flying geese units in two colorways.

- Organize and separate B triangles and C triangles by flying geese colorway. Create (8) units for one colorway, and (4) units for colorway two. Choose (1) colorway to begin piecing first.
- Begin flying geese unit assembly by placing (1) C triangle on either side of (1) B triangle.
- Sew the C triangles to the B triangles one at a time using a scant 1/4" seam. Press toward the corners.
- Trim flying geese units to measure 2 1/2" x 4 1/2" unfinished.
- Repeat to make (8) identical flying geese units in one colorway, and (4) identical flying geese units in colorway two. All units should measure 2 1/2" x 4 1/2" unfinished.

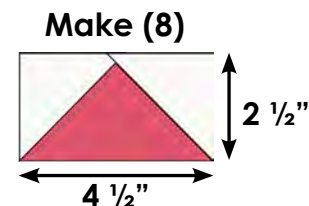
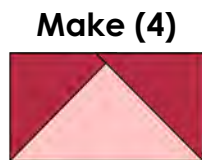
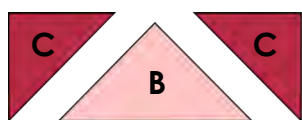

- Begin making the block star center using (4) identical flying geese units, (4) A squares and (1) D square. Lay out as shown.

7. Sew together in horizontal rows pressing all seams away from the flying geese units.
8. Sew horizontal rows together to complete the block star center. Trim the block star center to measure  $8\frac{1}{2}$ " x  $8\frac{1}{2}$ " unfinished.

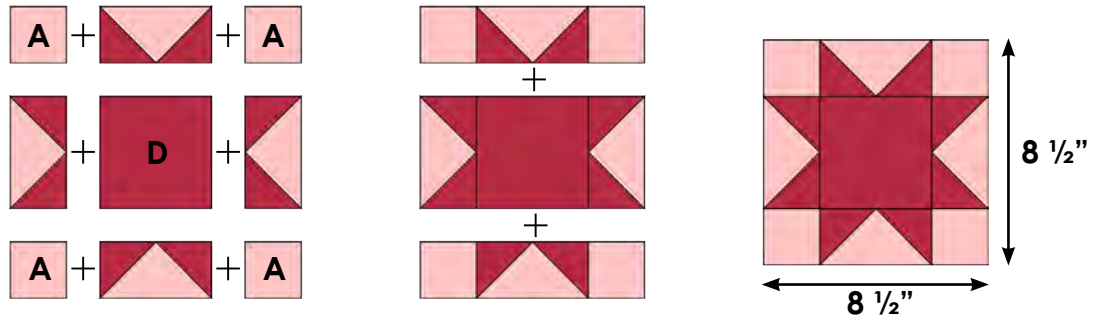

9. Continue block assembly by placing (4) A squares and (8) identical flying geese units around the block star center as shown. Please note the orientation of the outermost flying geese units.
10. Sew together in (3) horizontal rows. Arrows indicate pressing instructions.
11. Sew horizontal rows together to complete the block.
12. Press away from the block center star to complete. Completed block should measure  $12\frac{1}{2}$ " x  $12\frac{1}{2}$ " unfinished.

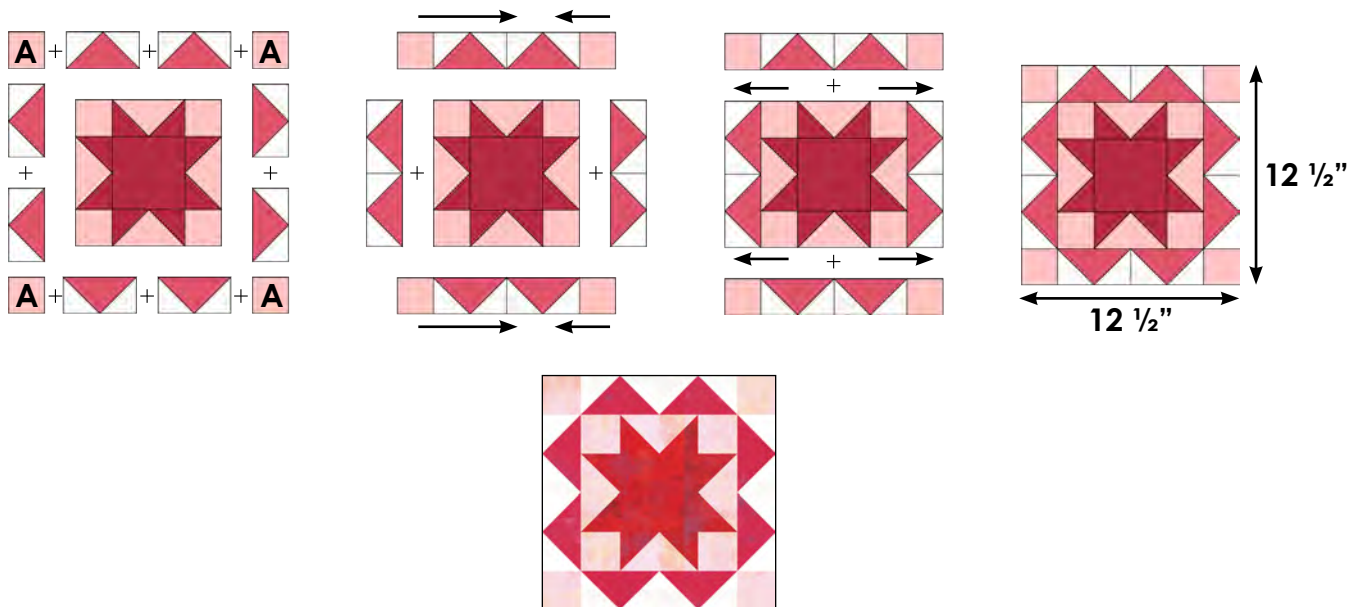

*Be sure to share your block and progress online!*

**#ModaStitchPink**



## Cutting

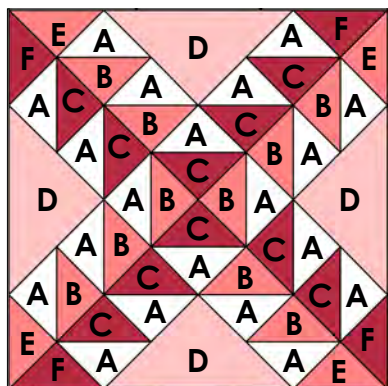

**(PLEASE NOTE: The block shown uses the same fabric for the B and E cut pieces, and the same fabric for the C and F cut pieces. Use a scant 1/4" seam when piecing this block.)**

<b>A</b>	(10) 3" squares; cut each square once diagonally to make (20) A triangles. <i>Grunge #30150 101</i>
<b>B</b>	(5) 3" squares; cut each square once diagonally to make (10) B triangles. <i>Grunge #30150 325</i>
<b>C</b>	(5) 3" squares; cut each square once diagonally to make (10) C triangles. <i>Grunge #30150 253</i>
<b>D</b>	(1) 7 1/4" square; cut the square twice diagonally to make (4) D triangles. <i>Grunge #30150 64</i>
<b>E</b>	(1) 4 1/4" square; cut the square twice diagonally to make (4) E triangles. <i>Grunge #30150 325</i>
<b>F</b>	(1) 4 1/4" square; cut the square twice diagonally to make (4) F triangles. <i>Grunge #30150 253</i>

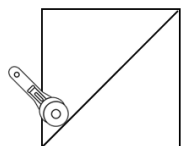

Cut Square Once Diagonally

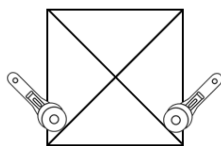

Cut Square Twice Diagonally

## Assembly

1. Begin HST unit assembly by placing (1) A triangle and (1) B triangle right sides together and edges aligned.
2. Sew along the longest edge using a 1/4" seam. Press toward the A triangle.
3. Trim the A/B HST unit to measure 2 5/8" x 2 5/8" unfinished. Repeat to make (10) A/B HST units.
4. Repeat HST unit assembly using (10) A triangles and (10) C triangles. Press toward the C triangles. Trim A/C HST units to measure 2 5/8" x 2 5/8" so that all HST units are the same size.
5. There should be (10) A/B HST units and (10) A/C HST units. Keep units separated by color for organization.
6. The block will be assembled diagonally. One section will run from the top left corner to the bottom right corner. The top right corner is a section and the bottom left corner is a section. Lay out A/B HST units, A/C HST units, D triangles, E triangles and F triangles are shown. HST units are turned throughout and colors alternated. Please note that the longest edges of the D triangles will create the sides of the block.

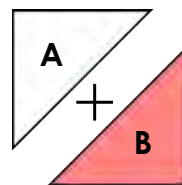

**Make (10)**

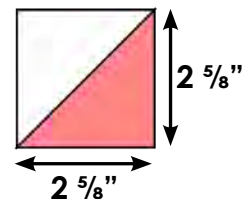

**Make (10)**

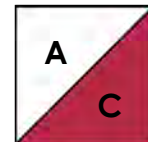

- Once you have confirmed that all units are placed correctly, begin sewing the center section together. HST units have been pressed to allow the seams to nestle. The diagrams show the center section in all stages of assembly. Arrows indicate pressing instructions, or press open.
- Sew the center section together and press thoroughly.

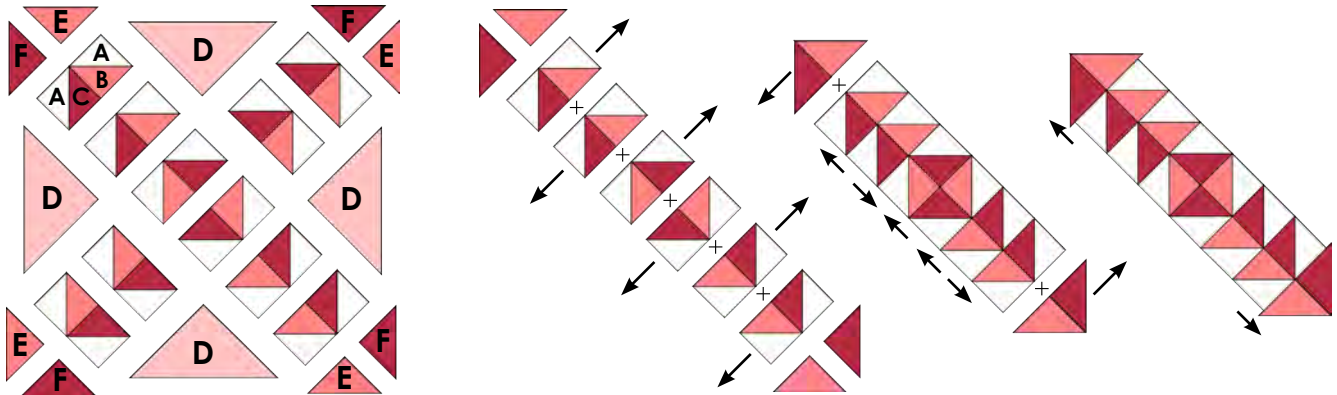

- Begin assembling the corner sections as shown. Ensure that HST units still alternate between fabrics during assembly. Arrows indicate pressing instructions.
- Sew the corner sections together and press thoroughly.

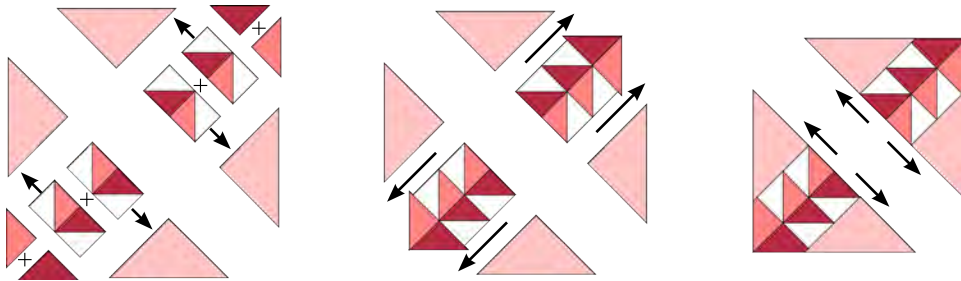

- Sew both corner sections onto both long edges of the center section. Use pins to help align and nestle seams.
- Once sewn, press seams outward and toward the corners to complete the block. Block should measure 12 1/2" x 12 1/2" unfinished.

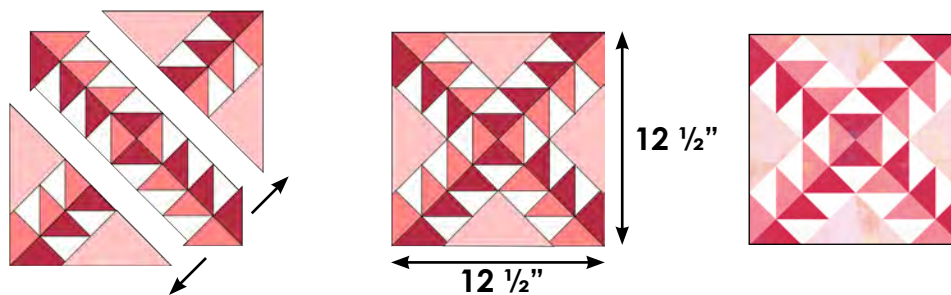

*Be sure to share your block and progress online!*

**#ModaStitchPink**



## Cutting

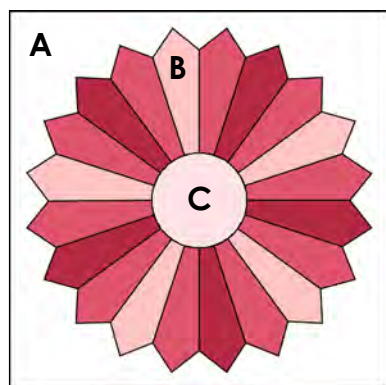

<b>A</b>	(1) 12 ½" x 12 ½" background square. <i>Grunge #30150 101</i>
<b>B</b>	(20) 2 ½" x 4 ½" assorted print rectangles for Dresden Blades. Use the Dresden Blade template provided to cut out (20) blades. <i>Grunge - 5 each of 365, 64, 10, 328</i>
<b>C</b>	(1) circle using the template provided. If you wish to complete raw edge applique, use the innermost black printed line when tracing. If you wish to complete turn under applique, use the outermost black printed line when tracing. <i>Grunge #30150 101</i>

## Assembly

1. Begin Dresden Block by preparing the blades. Fold each fabric Dresden Blade lengthwise and with right sides together.
2. Sew along the top edge of the Dresden Blade as shown in the diagram using a ¼" seam. Backstitch at the beginning and end of each seam thoroughly to secure.
3. Use a small pair of scissors to cut a small triangle from the seam allowance on the corner where the fabric is folded. That will create the Dresden Blade's point as shown. Do not cut through the thread. Cut right above the thread.
4. Turn the Dresden Blade right side out. Use your fingers or a special tool to carefully poke the Dresden's point out for a sharp appearance.
5. Press the interior seam open to reduce bulk at the Dresden's point. Press and starch for a nice finish.

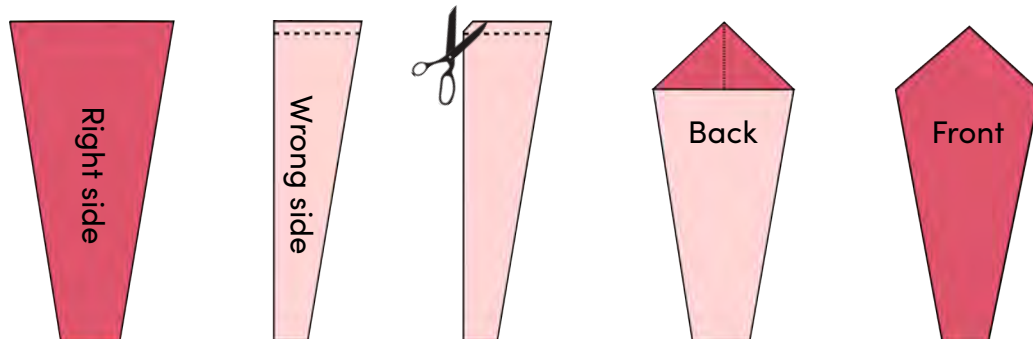

- Once all Dresden Blades are prepared, arrange blades in a circle as shown. Aim for even color and fabric distribution.
- Sew the circle together in quadrants of (5) blades each. Align the folded edges of (2) blades sewing from the top of the blade toward the bottom. The bottom raw edges will be covered upon completion of the block. Backstitch at the beginning and end of the seam to secure.
- Sew the quadrants together. You may press all seams in the same direction, or press all seams open.

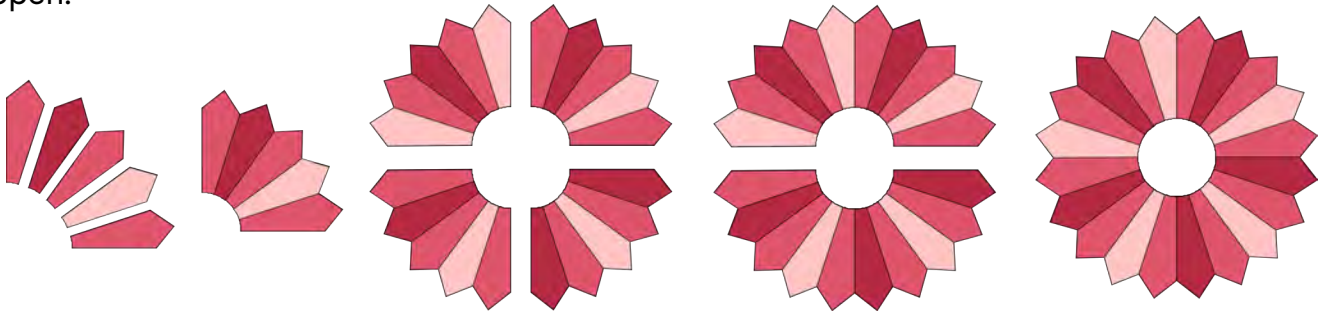

- Center the completed Dresden Plate onto the A square so that the edges of the Dresden Plate are at least  $\frac{1}{4}$ " away from the edges of the background square. Pin in place.

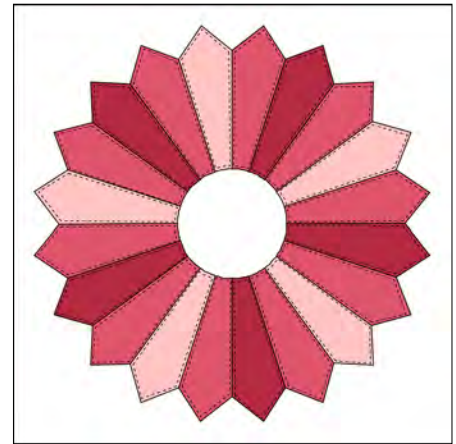

- Applique in place using a decorative stitch and thread color of your choice. Press.
- Prepare the fabric circle using your preferred applique method. Fabric circles can be prepared by using flip and fuse methods, turn under applique, needle turn applique, or raw edge with fusible interfacing.

- Place the prepared fabric circle onto the center of the block so that the raw edges of the Dresden Plate are covered by the circle. Pin in place.

- Applique in place using a decorative stitch and thread color of your choice to complete the block. Block should measure  $12\frac{1}{2}$ " x  $12\frac{1}{2}$ " unfinished.

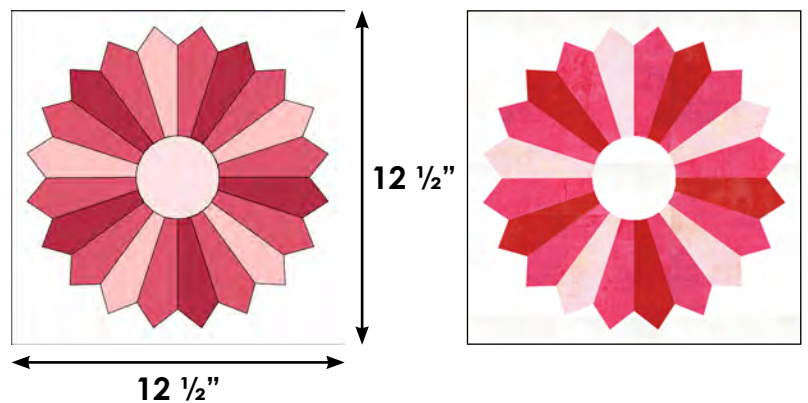

*Be sure to share your block and progress online!*

**#ModaStitchPink**



# Dresden Templates



Block 7  
Jersey Girl

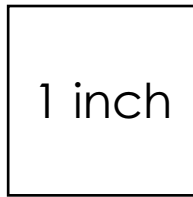

1 inch

*Ensure that block measures 1".*

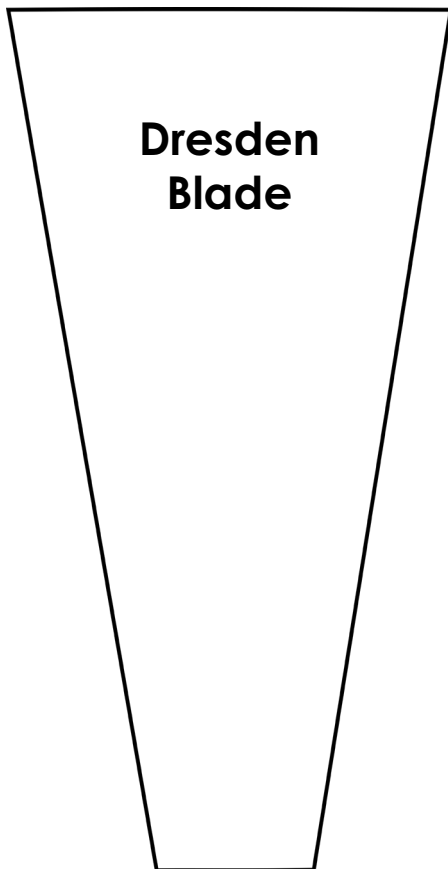

**Dresden  
Blade**

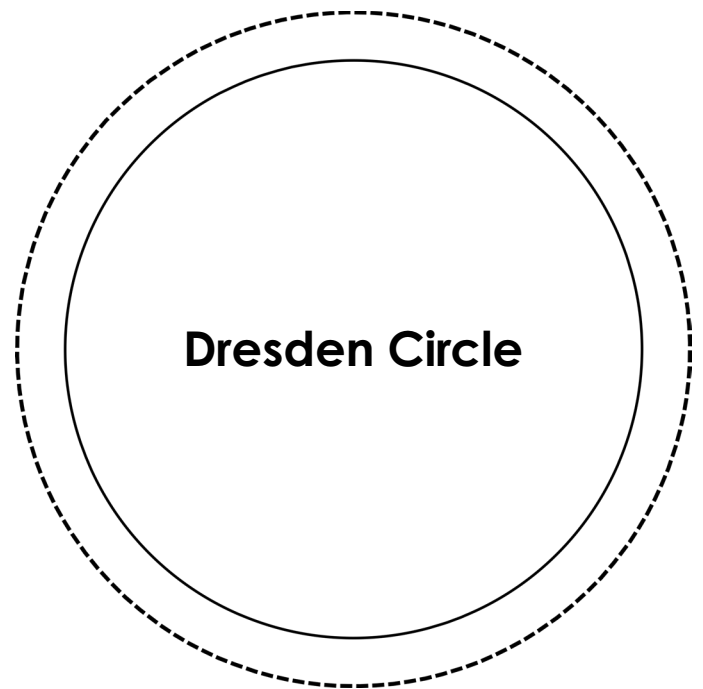

**Dresden Circle**

To make the best use of fabric, color 254, cut 1- 10 1/4" square and set aside for Block 14.

## Cutting

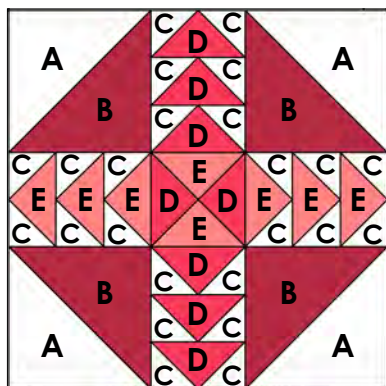

<b>A</b>	(2) 5 3/8" squares; cut each square once diagonally to make (4) A triangles. <i>Grunge #30150 101</i>
<b>B</b>	<u>Before cutting see note above</u> (2) 5 3/8" squares; cut each square once diagonally to make (4) B triangles. <i>Grunge #30150 254</i>
<b>C</b>	(12) 2 3/8" squares; cut each square once diagonally to make (24) C triangles. <i>Grunge #30150 101</i>
<b>D</b>	(2) 4 1/4" squares; cut each square twice diagonally to make (8) D triangles. <i>Grunge #30150 325</i>
<b>E</b>	(2) 4 1/4" squares; cut each square twice diagonally to make (8) E triangles. <i>Grunge #30150 332</i>

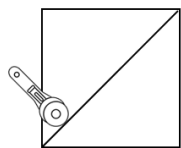

Cut Square Once Diagonally

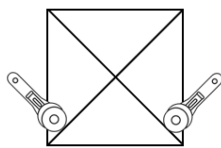

Cut Square Twice Diagonally

## Assembly

- Flying geese units are created in two colorways. Begin colorway 1 using (12) C triangles and (6) D triangles. Centering the C triangles, sew the longest edges of (2) C triangles to either side of (1) D triangle as shown. Press seams outward toward the corner.
- Repeat to make (6) C/D flying geese units. Trim flying geese units to measure 2" x 3 1/2" unfinished.

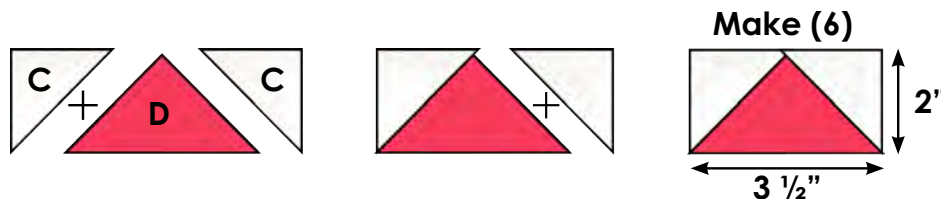

- Repeat flying geese unit assembly techniques to make (6) units using C and E triangles. Diagrams show accurate fabric placement. Trim flying geese units to measure 2" x 3 1/2" unfinished.

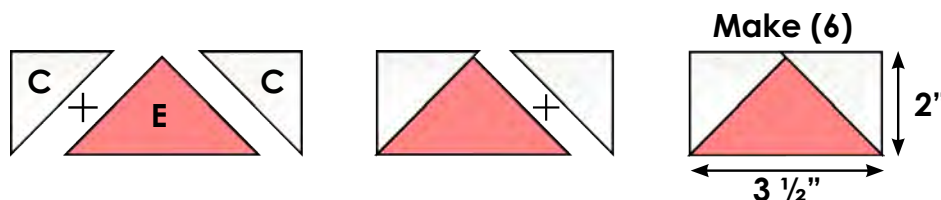



4. Lay out (2) D triangles and (2) E triangles to form a QST unit as shown. The longest edges of each triangle will form the outside edges of the unit.

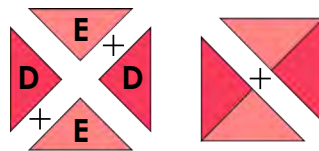

Block 8

*Fly Away Home*

5. Sew together, pressing to the dark fabric.

6. Trim the QST unit to measure  $3\frac{1}{2}''$  x  $3\frac{1}{2}''$  unfinished.

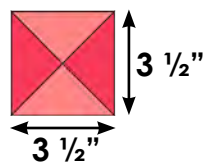

7. Begin HST unit assembly using (4) A triangles and (4) B triangles. Place A and B triangles right sides together and edges aligned.

8. Sew along the longest edge using a  $\frac{1}{4}''$  seam. Press to the dark fabric.

9. Trim all (4) HST units to measure  $5''$  x  $5''$  unfinished.

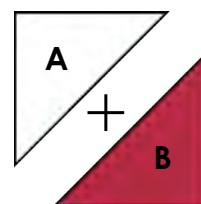

**Make (4)**

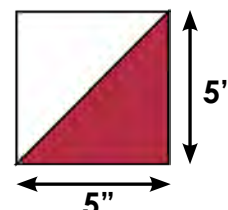

10. Begin block assembly by laying out all flying geese units, all HST units and the QST unit in the center of the block. Keep C/D and C/E flying geese units separated by colorway as shown.

11. Sew the block together in (3) horizontal rows. Arrows indicate pressing instructions.

12. Sew horizontal rows together to complete the block, pressing away from the center row to complete. Block should measure  $12\frac{1}{2}''$  x  $12\frac{1}{2}''$  unfinished.

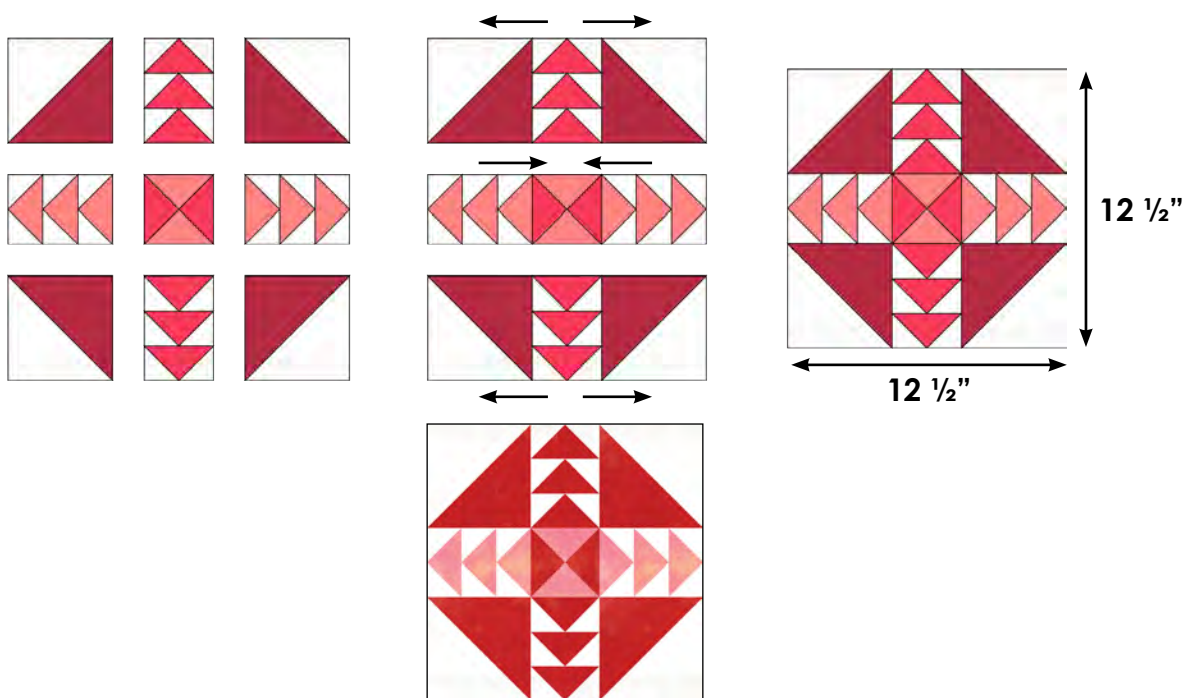

*Be sure to share your block and progress online!*

**#ModaStitchPink**



## Cutting

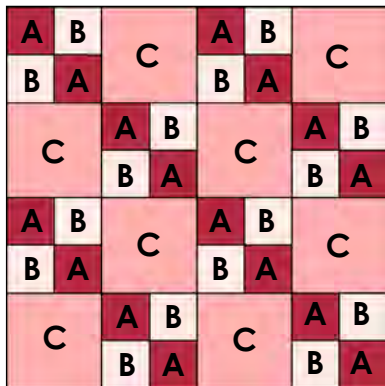

<b>A</b>	(16) 2" squares. <i>Grunge #30150 253</i>
<b>B</b>	(16) 2" squares. <i>Grunge #30150 101</i>
<b>C</b>	(8) 3 1/2" x 3 1/2" squares. <i>Grunge #30150 64</i>

## Assembly

- Begin block assembly by creating 4-patch units. Sew (2) A squares and (2) B squares into a 2 x 2 grid, alternating between prints. Press toward the darkest fabric.
- Repeat to make (8) identical 4-patch units measuring 3 1/2" x 3 1/2" unfinished.
- Lay out all 4-patch units created in the above steps and (8) C squares in an alternating pattern. Please note that A and B squares should create chains throughout the block running opposite directions.
- Sew the units together in (4) horizontal rows pressing toward the C squares.
- Sew the horizontal rows together to complete the block. Press to complete. Block should measure 12 1/2" x 12 1/2" unfinished.

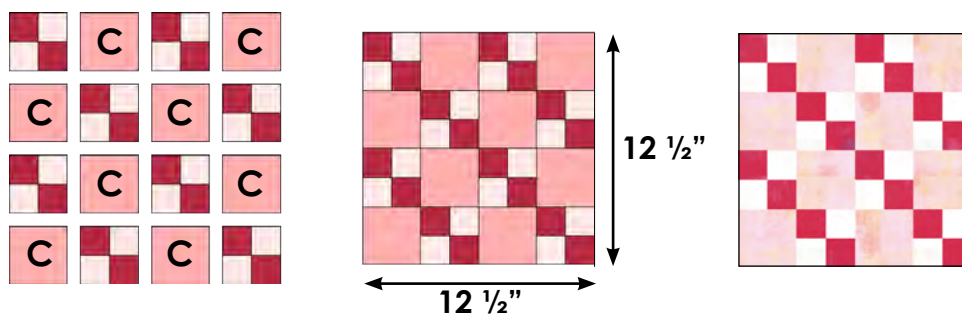
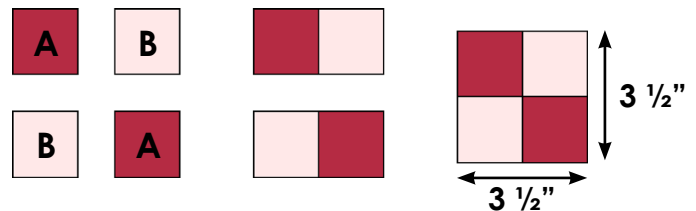

Be sure to share your block and progress online!  
**#ModaStitchPink**

## Cutting

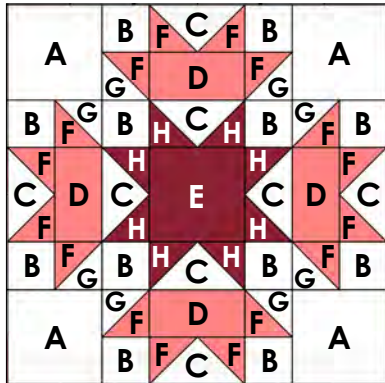

<b>A</b>	(4) 3 1/2" squares. <i>Grunge #30150 101</i>
<b>B</b>	(12) 2" squares. <i>Grunge #30150 101</i>
<b>C</b>	(2) 4 1/4" squares; cut squares twice diagonally to make (8) C triangles. <i>Grunge #30150 101</i>
<b>D</b>	(4) 2" x 3 1/2" rectangles. <i>Grunge #30150 377</i>
<b>E</b>	(1) 3 1/2" square. <i>Grunge #30150 82</i>
<b>F</b>	(8) 2 3/8" squares; cut squares once diagonally to make (16) F triangles. <i>Grunge #30150 377</i>
<b>G</b>	(4) 2 3/8" squares; cut squares once diagonally to make (8) G triangles. <i>Grunge #30150 101</i>
<b>H</b>	(4) 2 3/8" squares; cut squares once diagonally to make (8) H triangles. <i>Grunge #30150 82</i>

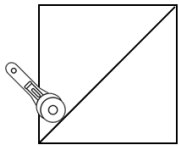

Cut Square Once Diagonally

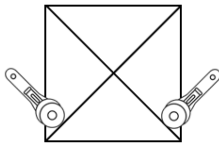

Cut Square Twice Diagonally

## Assembly

1. Make (8) HST units using (8) F triangles and (8) G triangles. Sew the longest edges of the triangles together using a 1/4" seam. Press toward the dark fabric.
2. Trim F/G HST units to measure 2" x 2" unfinished.
3. Sew the longest edges of (2) F triangles onto either side of (1) C triangle as shown. Press seams outward. Repeat to make (4) flying geese units using F and C triangles.
4. Repeat flying geese unit assembly using (2) H triangles and (1) C triangle. Repeat to create (4) flying geese units using H and C triangles.
5. Trim all flying geese units to measure 2" x 3 1/2" unfinished. There should be (8) total flying geese units, (4) of each colorway.

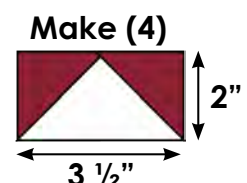
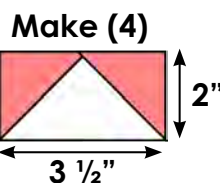
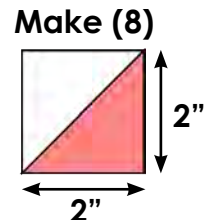
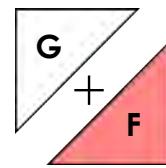

6. Complete the center of the block using (4) H/C flying geese units, (4) B squares and (1) E square. Press to the B and E squares. Block center should measure  $6\frac{1}{2}$  x  $6\frac{1}{2}$ " unfinished.



Block 10  
Helen

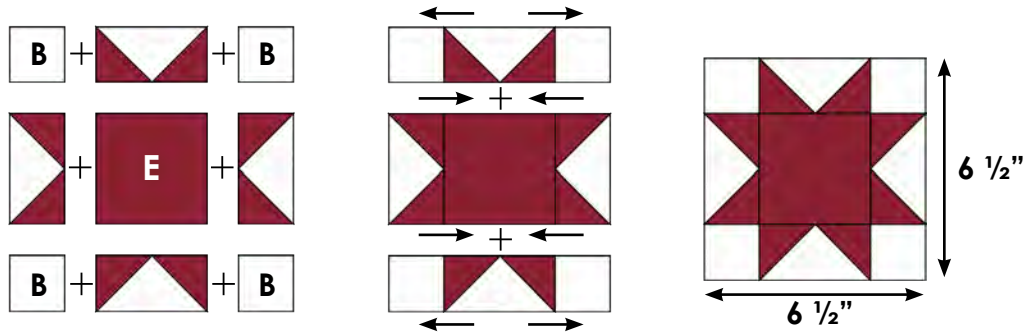

7. Complete block assembly using all units created in the above steps and the remaining A squares, B squares and D rectangles. Arrows indicate pressing instructions. Diagrams show the block in all stages of assembly. Completed block should measure  $12\frac{1}{2}$  x  $12\frac{1}{2}$ " unfinished.

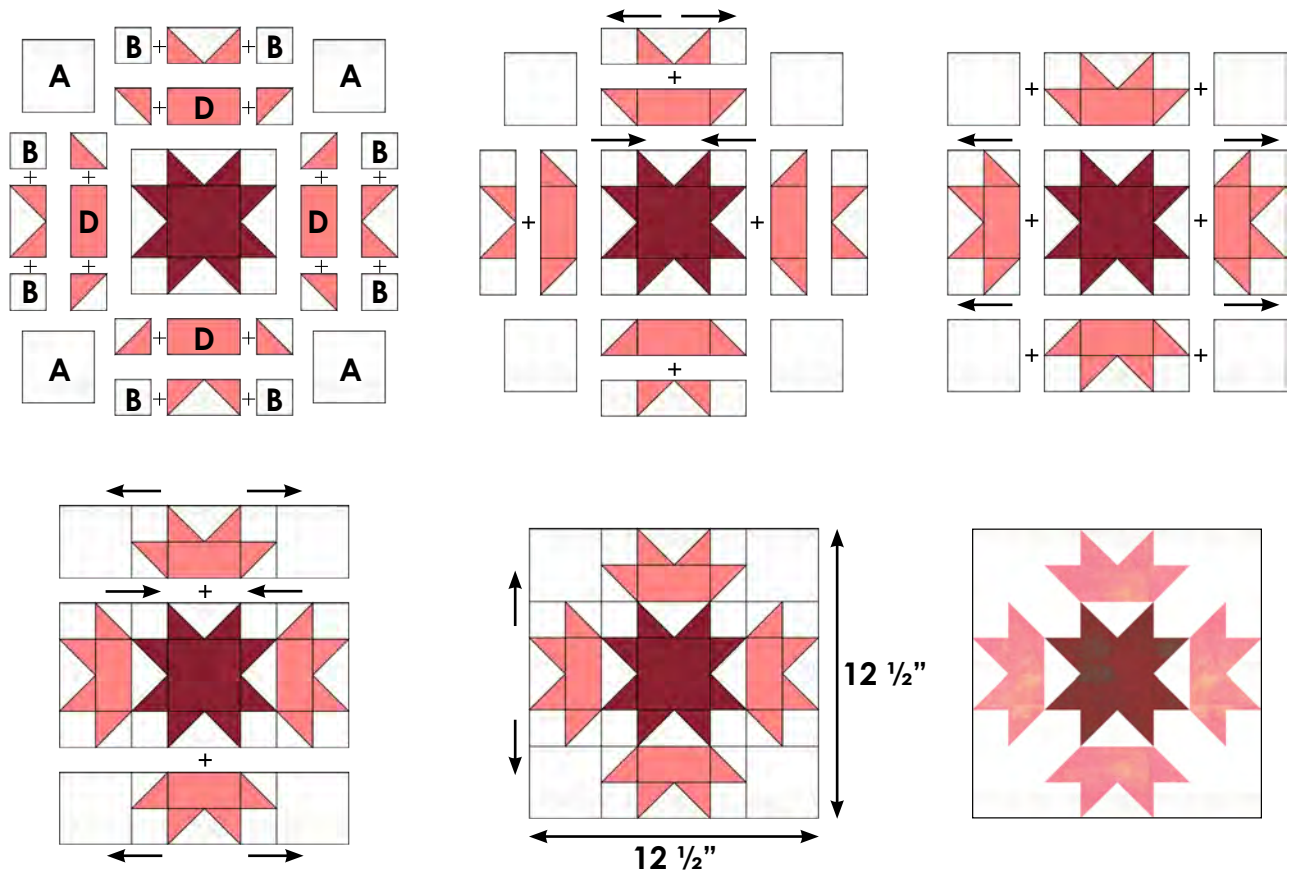

Be sure to share your block and progress online!  
#ModaStitchPink



## Cutting

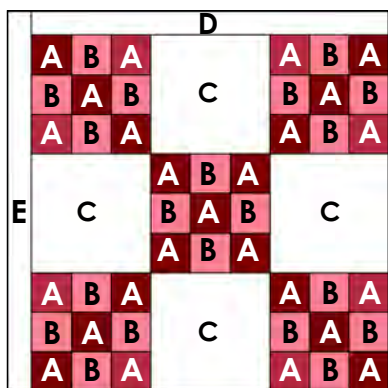

**PLEASE NOTE:** "A" cut pieces are shown using (2) fabrics. Plan fabric choices and adjust cutting accordingly.

<b>A</b>	(25) 1 3/4" squares. <i>Grunge - 17 from 82, 6 from 328</i>
<b>B</b>	(20) 1 3/4" squares. <i>Grunge 30150-377</i>
<b>C</b>	(4) 4 1/4" squares. <i>Grunge 30150-101</i>
<b>D</b>	(1) 1 1/4" x 11 3/4" rectangle. <i>Grunge 30150-101</i>
<b>E</b>	(1) 1 1/4" x 12 1/2" rectangle. <i>Grunge 30150-101</i>

## Assembly

1. Make 9-patch units using (5) A squares and (4) B squares. Lay out squares as shown, alternating between fabrics. When sewing, press toward the darkest fabric.
2. Repeat to make (4) identical 9-patch units mixing A fabric prints. Make (1) 9-patch unit using (4) B squares and (5) matching A squares. 9-patch units should measure 4 1/4" x 4 1/4" unfinished.

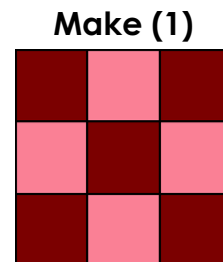
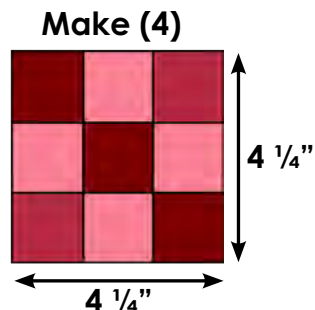
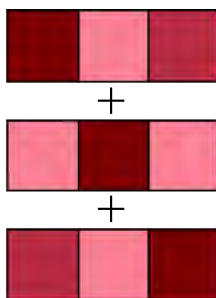
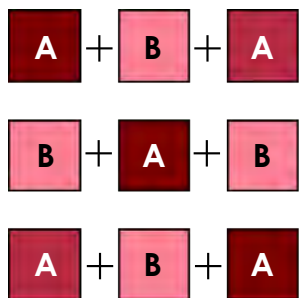

- Place (5) 9-patch units and (4) C squares in a 3 x 3 grid as shown. Sew together in (3) horizontal rows pressing towards the C squares.
- Sew horizontal rows together and press toward the center row. Block should measure  $11 \frac{3}{4}$ " x  $11 \frac{3}{4}$ " at this step.



Block 11  
Five and Nine

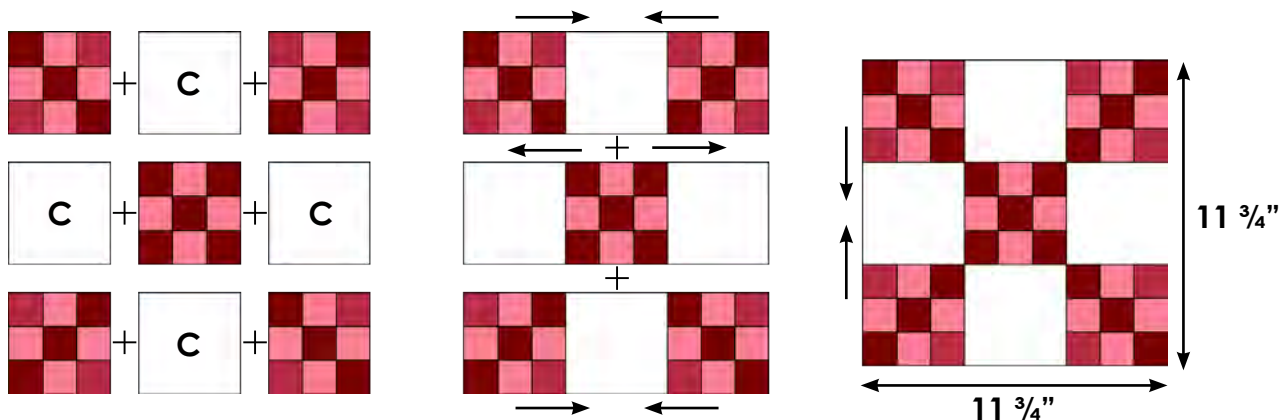

- Next sew (1) D rectangle to the top of the block. Press outward.
- Last sew (1) E rectangle to the left side of the block. Press outward to complete block assembly. Block should measure  $12 \frac{1}{2}$ " x  $12 \frac{1}{2}$ " unfinished.

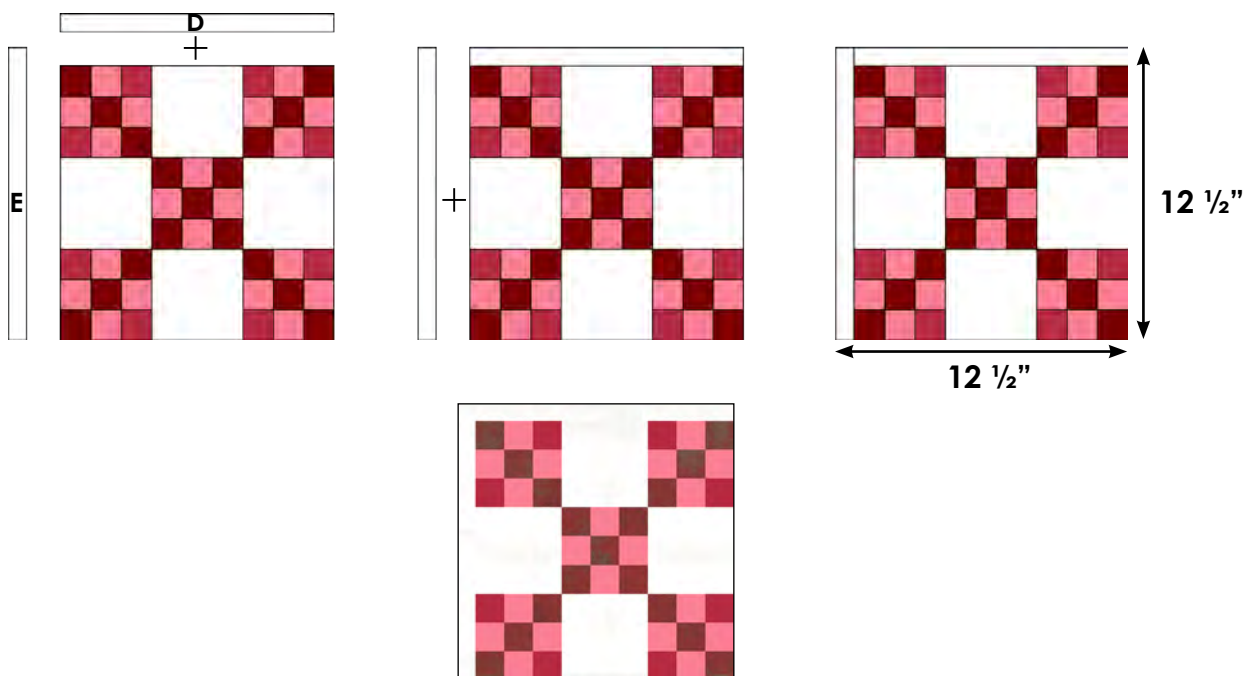

Be sure to share your block and progress online!

#ModaStitchPink



## Cutting

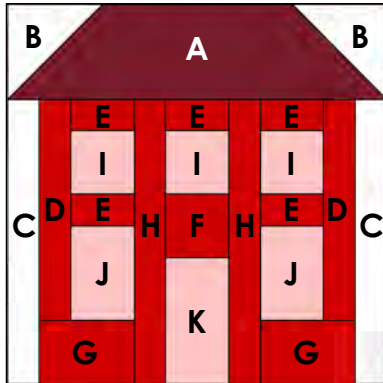

<b>A</b>	(1) 3 1/2" x 12 1/2" rectangle. <i>Grunge 30150-82</i>
<b>B</b>	(2) 3 1/2" squares; draw a diagonal line from corner to corner on the wrong side. <i>Grunge 30150-101</i>
<b>C</b>	(2) 1 1/2" x 9 1/2" rectangles. <i>Grunge 30150-101</i>
<b>D</b>	(2) 1 1/2" x 7 1/2" rectangles. <i>Grunge 30150-365</i>
<b>E</b>	(5) 1 1/2" x 2 1/2" rectangles. <i>Grunge 30150-365</i>
<b>F</b>	(1) 2 1/2" square. <i>Grunge 30150-365</i>
<b>G</b>	(2) 2 1/2" x 3 1/2" rectangles. <i>Grunge 30150-365</i>
<b>H</b>	(2) 1 1/2" x 9 1/2" rectangles. <i>Grunge 30150-365</i>
<b>I</b>	(3) 2 1/2" squares. <i>Grunge 30150-64</i>
<b>J</b>	(2) 2 1/2" x 3 1/2" rectangles. <i>Grunge 30150-64</i>
<b>K</b>	(1) 2 1/2" x 4 1/2" rectangle. <i>Grunge 30150-377</i>

## Assembly

1. Create the roof for the house by placing (1) B square with a drawn diagonal line onto both corners of the A rectangle, right sides together and edges aligned. Diagrams show accurate B square placement.
2. Stitch along the drawn diagonal lines. Trim outermost excess fabric to 1/4". Press to the corner to complete the roof.



- Use the labeled diagram below to lay out the roof and remaining cut pieces C-K correctly. Follow the series of diagrams below to complete the house in stages. For all seams, press away from the windows, door, background and roof.
- Press to complete. Block should measure 12 1/2" x 12 1/2" unfinished.

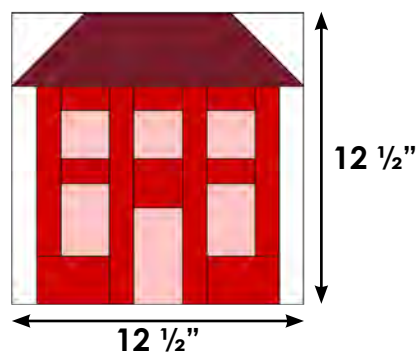
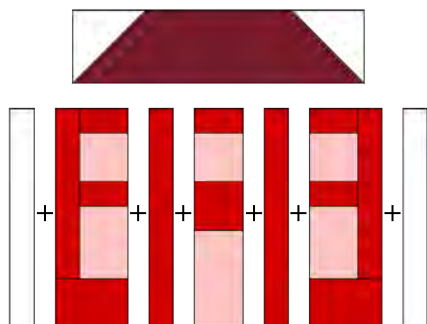
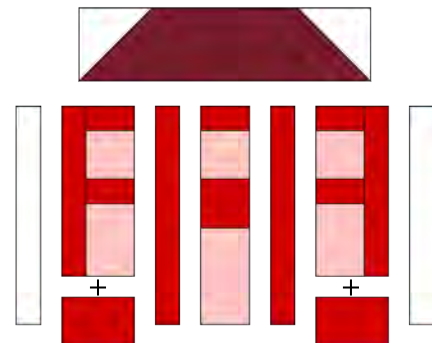
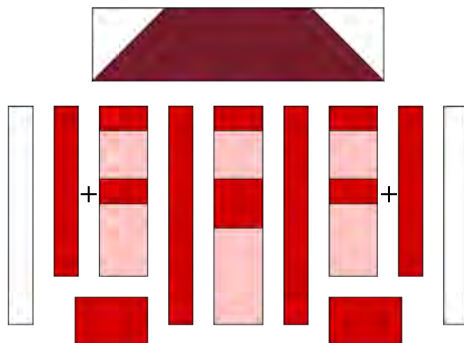
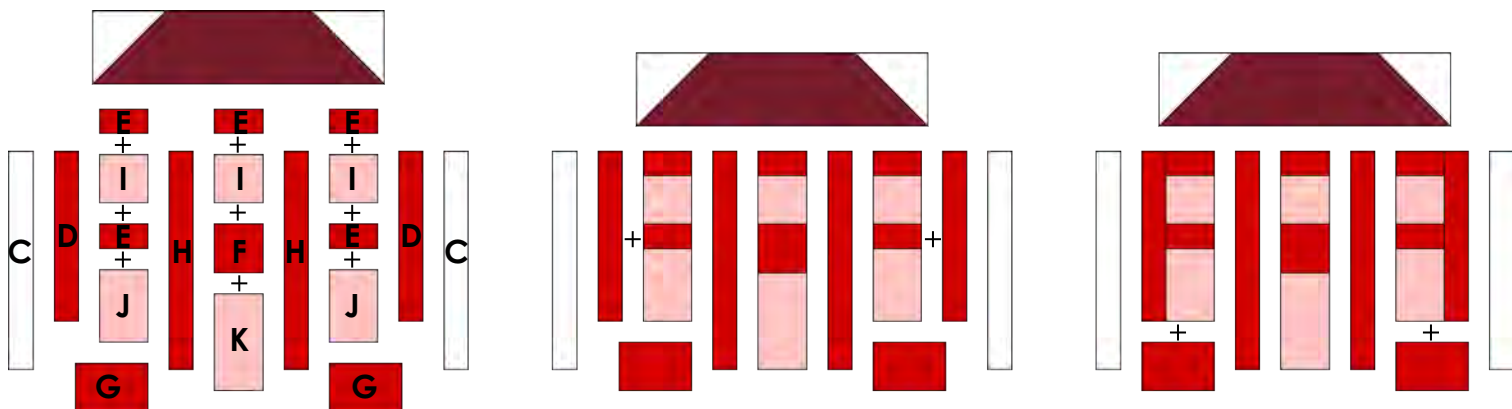

Be sure to share your block and progress online!

#ModaStitchPink





## Cutting

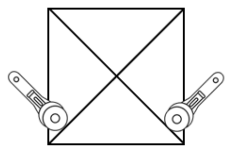
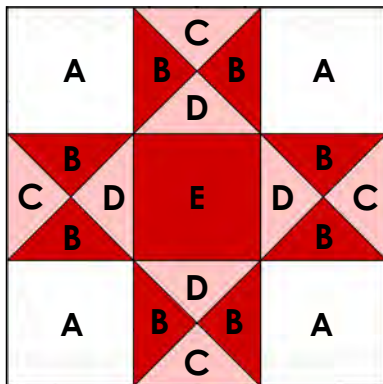

Cut Square Twice Diagonally

<b>A</b>	(4) 4 ½" squares. <i>Grunge 30150-101</i>
<b>B</b>	(2) 5 ¼" squares; cut each square twice diagonally from corner to corner to make (8) B triangles. <i>Grunge 30150-332</i>
<b>C</b>	(1) 5 ¼" square; cut squares twice diagonally from corner to corner to make (4) triangles. <i>Grunge 30150-325</i>
<b>D</b>	(1) 5 ¼" square; cut the square twice diagonally from corner to corner to make (4) triangles. <i>Grunge 30150-325</i>
<b>E</b>	(1) 4 ½" square. <i>Grunge 30150-332</i>

## Assembly

1. Begin making QST units by laying out (2) B triangles and (1) C and D triangle as shown. B triangles should be opposite one another, and C and D triangles should be opposite one another.
2. Sew together as shown, pressing toward the B triangles.
3. Sew the halves together to complete the QST unit. Press.
4. Repeat to make (4) identical QST units measuring 4 ½" x 4 ½" unfinished.

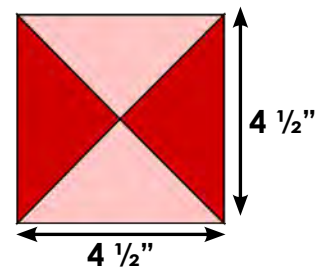
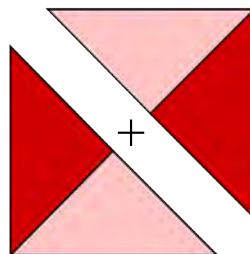
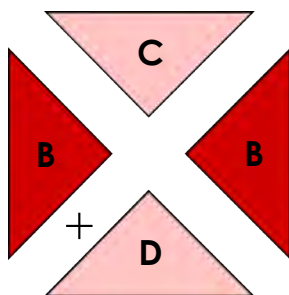

5. Begin block assembly by laying out (4) QST units, (4) A squares and (1) E square as shown. Ensure that QST units are oriented correctly.
6. Sew together in rows, pressing away from the QST units.
7. Sew rows together to complete the block. Block should measure 12 1/2" x 12 1/2" unfinished.

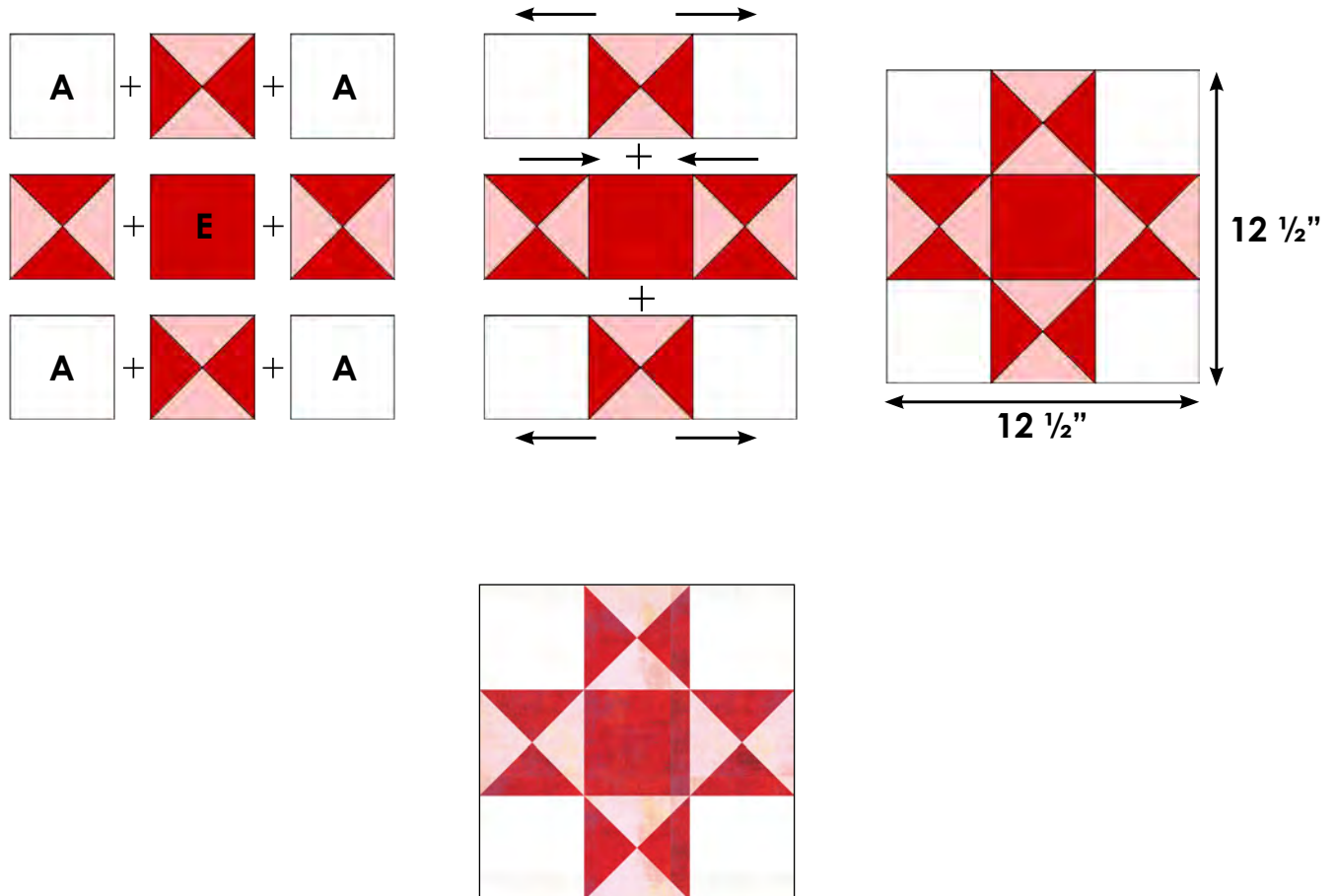

*Be sure to share your block and progress online!*

**#ModaStitchPink**



## Cutting

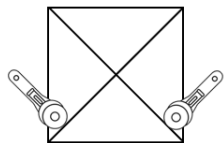
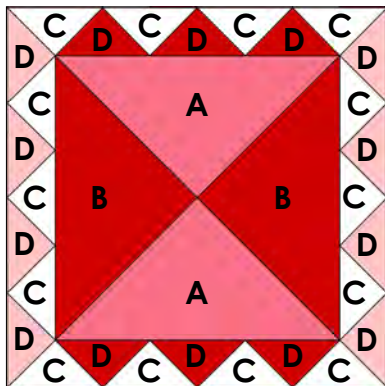

Cut Square Twice  
Diagonally

**PLEASE NOTE:** The block diagrams are shown using (2) fabrics for the "D" units. Plan cutting and fabric placement before proceeding. Use a scant  $\frac{1}{4}$ " seam when piecing this block.

<b>A</b>	(1) $10 \frac{1}{4}$ " square; cut the square twice diagonally to make (4) A triangles. Please note that (2) triangles will be unused. <i>Grunge 30150-325</i>
<b>B</b>	(1) $10 \frac{1}{4}$ " square; cut the square twice diagonally to make (4) B triangles. Please note that (2) triangles will be unused. <i>Grunge 30150-254</i>
<b>C</b>	(4) $4 \frac{1}{4}$ " squares; cut each square twice diagonally to make (16) C triangles. Please note that (2) triangles will be unused. <i>Grunge 30150-101</i>
<b>D</b>	(4) $4 \frac{1}{4}$ " squares; cut each square twice diagonally to make (16) D triangles. Please note that (2) triangles will be unused. <i>Grunge - 2 each from 30150-325 &amp; 30150-254.</i>

## Assembly

1. Make a QST unit for the center of the block using (2) A triangles and (2) B triangles. The longest edges of the triangles will create the outside edges of the QST unit.
2. Sew together as shown, pressing seams to the B triangles. Once complete, trim the QST unit to measure  $9 \frac{1}{2}$ " x  $9 \frac{1}{2}$ " unfinished.

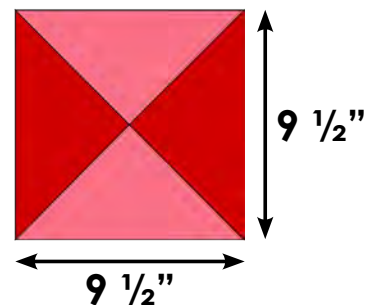
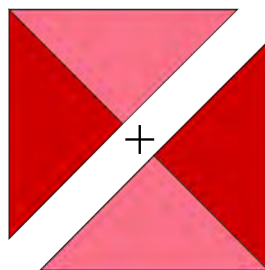
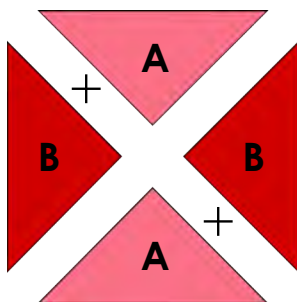

3. Lay out C and D triangles around the QST unit as shown, alternating between fabrics.

4. Once you have confirmed that the layout is correct, begin sewing the top, bottom and side triangle units together as shown. Sew the C/D triangles present at the four corners of the block together as shown leaving those separate from the side units at this time.
5. Attach top, bottom and side triangle units to the QST unit. Press outward and away from the QST unit. (Please note that the C/D triangles are not sewn to the corners at this step.)
6. Attach the C/D triangle units to the four corners to complete the block.
7. Press the C/D triangle units outward to complete the block. Completed block should measure 12 1/2" x 12 1/2" unfinished.

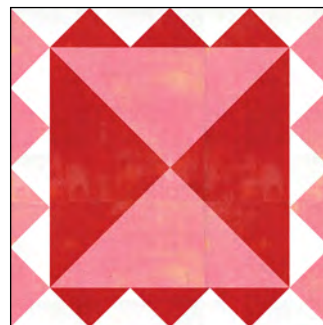
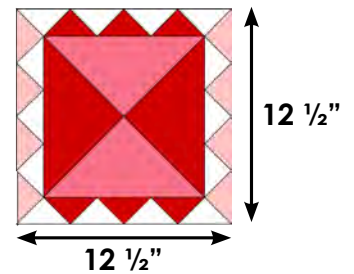
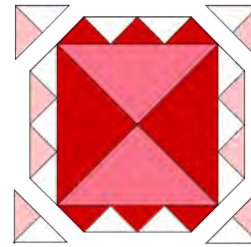
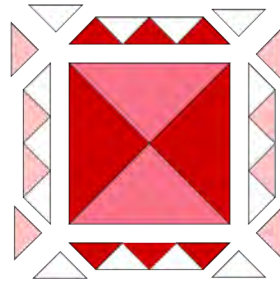
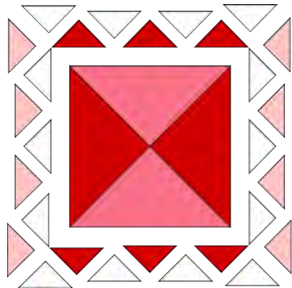
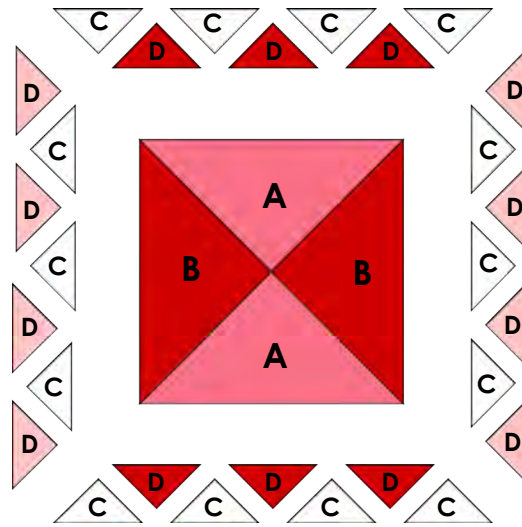

*Be sure to share your block and progress online!*  
**#ModaStitchPink**



## Cutting

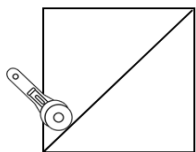
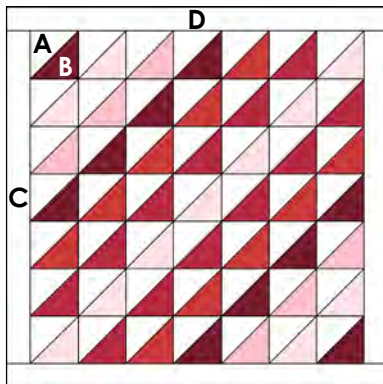

Cut Square Once Diagonally

**PLEASE NOTE:** The block features B triangles using (5) fabrics. Plan your fabric selections and fabric placement before proceeding with "B" cutting.

<b>A</b>	(25) 2 3/8" squares; cut each square once diagonally to make (50) A triangles. (1) triangle will be unused. <i>Grunge #30150 101</i>
<b>B</b>	(25) 2 3/8" squares; cut each square once diagonally to make (50) B triangles. (1) triangle will be unused. <i>Grunge - cut 5-82, 6-64, 5-332, 6-253 &amp; 3-325</i>
<b>C</b>	(2) 1 1/4" x 11" rectangles. <i>Grunge #30150 101</i>
<b>D</b>	(2) 1 1/4" x 12 1/2 rectangles. <i>Grunge #30150 101</i>

## Assembly

1. Begin block assembly by creating HST units. (Please note: HST units may vary in color as shown in the block diagrams. Trim measurements and instructions remain the same. Plan fabrics accordingly.) Place (1) A triangle with (1) B triangle, right sides together and edges aligned.
2. Sew along the longest edge of the triangles using a 1/4" seam. Press toward the dark fabric.
3. Trim HST unit to measure 2" x 2" unfinished.
4. Repeat to make (49) HST units of the same size using the instructions above.
5. Once HST unit assembly is complete, arrange HST units in the color pattern of your choice in a 7 x 7 grid. Sew HST units together in (7) horizontal rows, alternating the direction in which you press the seams in each row as shown in the diagram.
6. Sew horizontal rows together to complete the block center. Press downward, or press open.

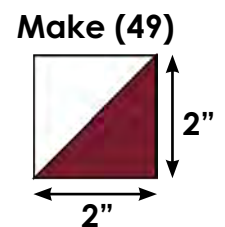
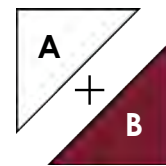



Block 15  
Tweet Tweet

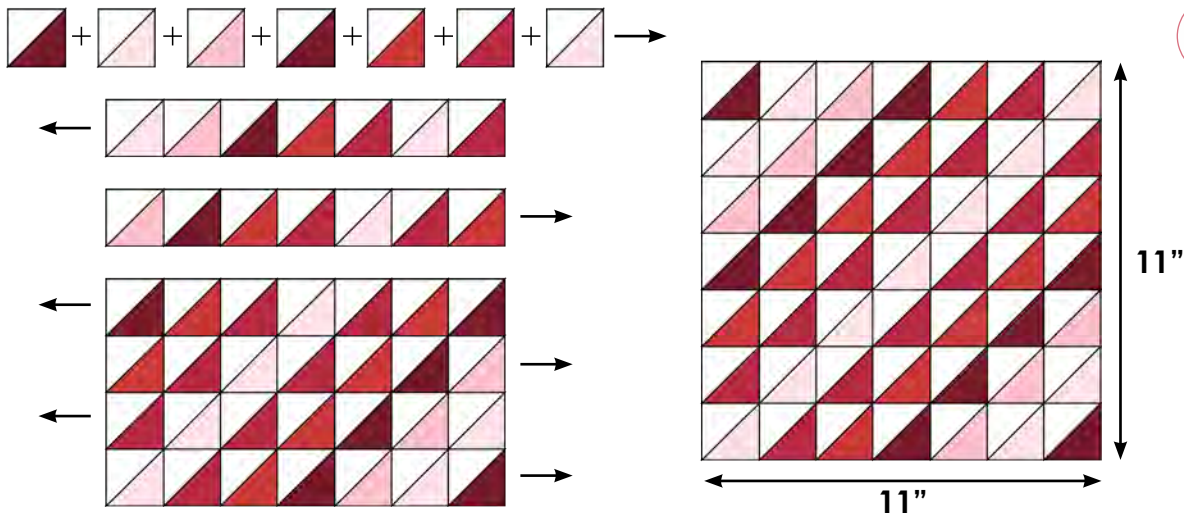

7. Sew (1) C rectangle onto either side of the block center. Press outward.
8. Sew (1) D rectangle onto the top and bottom of the block center. Press outward to complete. Complete block should measure  $12\frac{1}{2}$ " x  $12\frac{1}{2}$ " unfinished.

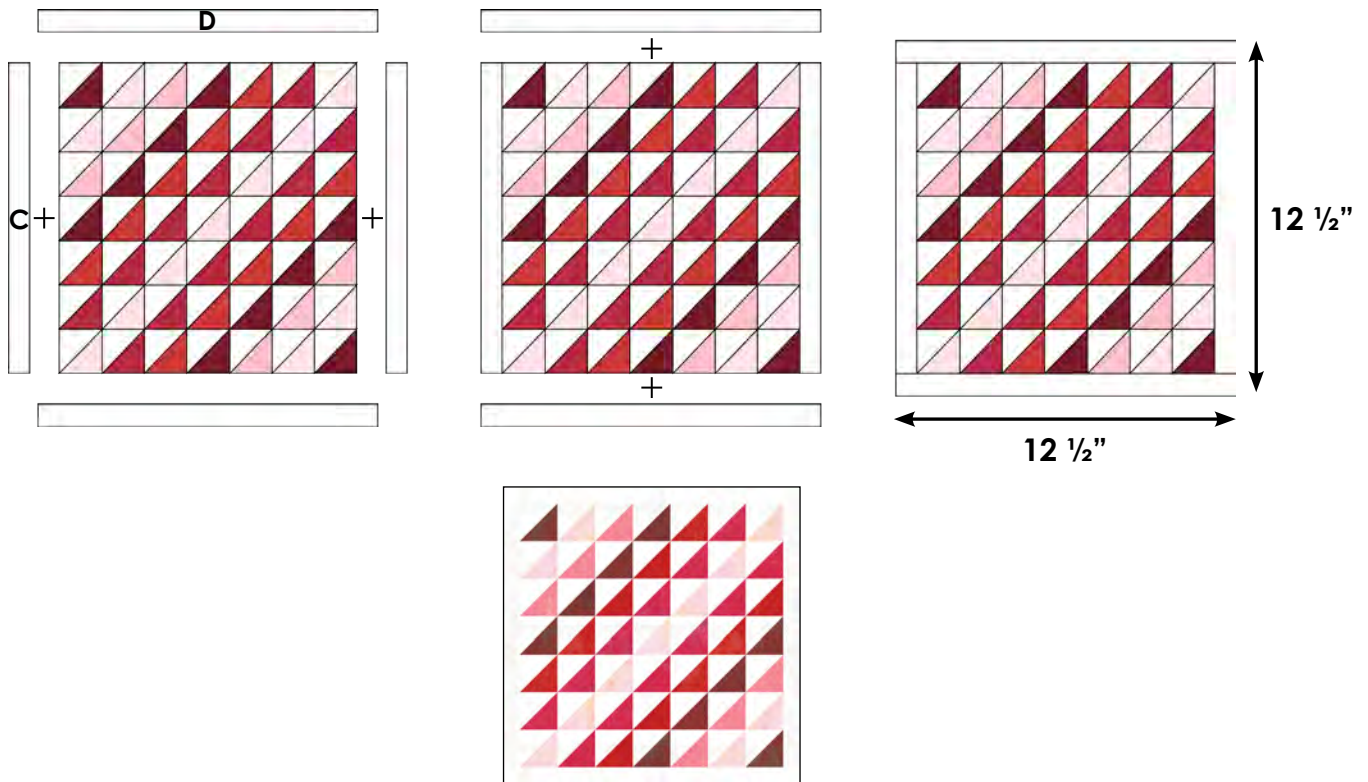

Be sure to share your block and progress online!  
[#ModaStitchPink](https://twitter.com/ModaStitchPink)



## Cutting

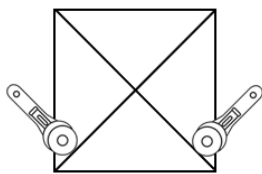
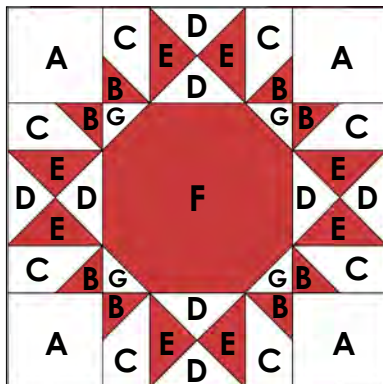

Cut Square Twice  
Diagonally

<b>A</b>	(4) 3 1/2" squares. <i>Grunge 30150-101</i>
<b>B</b>	(8) 2" squares; draw a diagonal line from corner to corner on the wrong side. <i>Grunge 30150-332</i>
<b>C</b>	(8) 2" x 3 1/2" rectangles. <i>Grunge 30150-101</i>
<b>D</b>	(2) 4 1/4" squares; cut each square twice diagonally to make (8) D triangles. <i>Grunge 30150-101</i>
<b>E</b>	(2) 4 1/4" squares; cut each square twice diagonally to make (8) E triangles. <i>Grunge 30150-254</i>
<b>F</b>	(1) 6 1/2" square. <i>Grunge 30150-254</i>
<b>G</b>	(4) 2" squares; draw a diagonal line from corner to corner on the wrong side. <i>Grunge 30150-101</i>

## Assembly

1. Begin block assembly by making QST units. Place (2) D triangles and (2) E triangles together as shown. The longest edges of the triangles will create the edges of the QST unit.
2. Sew together as shown, pressing toward the dark fabric.
3. Repeat to make (4) identical QST units measuring 3 1/2" x 3 1/2" unfinished.
4. Continue block assembly by making stitch and flip units. Place (1) B square with a drawn diagonal line onto the bottom corner of (1) C rectangle, right sides together and edges aligned. Diagrams show accurate B square placement.
5. Sew along the drawn diagonal line. Trim outermost excess fabric to 1/4" and press to the corner.
6. Repeat to make (4) identical stitch and flip units in which the B square is placed on the bottom left corner, and (4) mirror image stitch and flip units in which the B square is placed on the bottom right corner. All stitch and flip units created in this step should measure 2" x 3 1/2" unfinished.

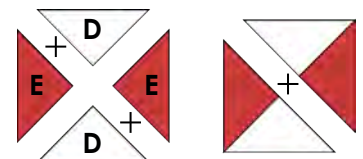

Make (4)

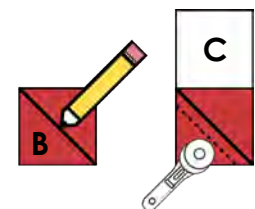
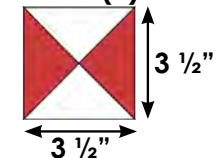

Make (4)



Make (4)

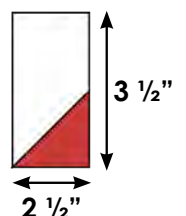

- Using stitch and flip techniques described above, attach (4) G squares to all corners of (1) F square as shown to make the block center. Press outward. Stitch and flip unit created in this step should measure  $6\frac{1}{2}'' \times 6\frac{1}{2}''$  unfinished.

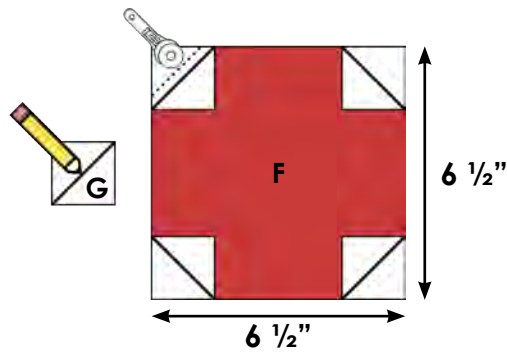

- Lay out all stitch and flip units created in Steps 4-6, the block center, (4) QST units and (4) A squares as shown. Please note the orientation and placement of the stitch and flip units.
- Once you have confirmed all units are placed correctly, sew together as shown in the diagram. Arrows indicate pressing instructions.
- Sew block together to complete. Press. Completed block should measure  $12\frac{1}{2}'' \times 12\frac{1}{2}''$  unfinished.

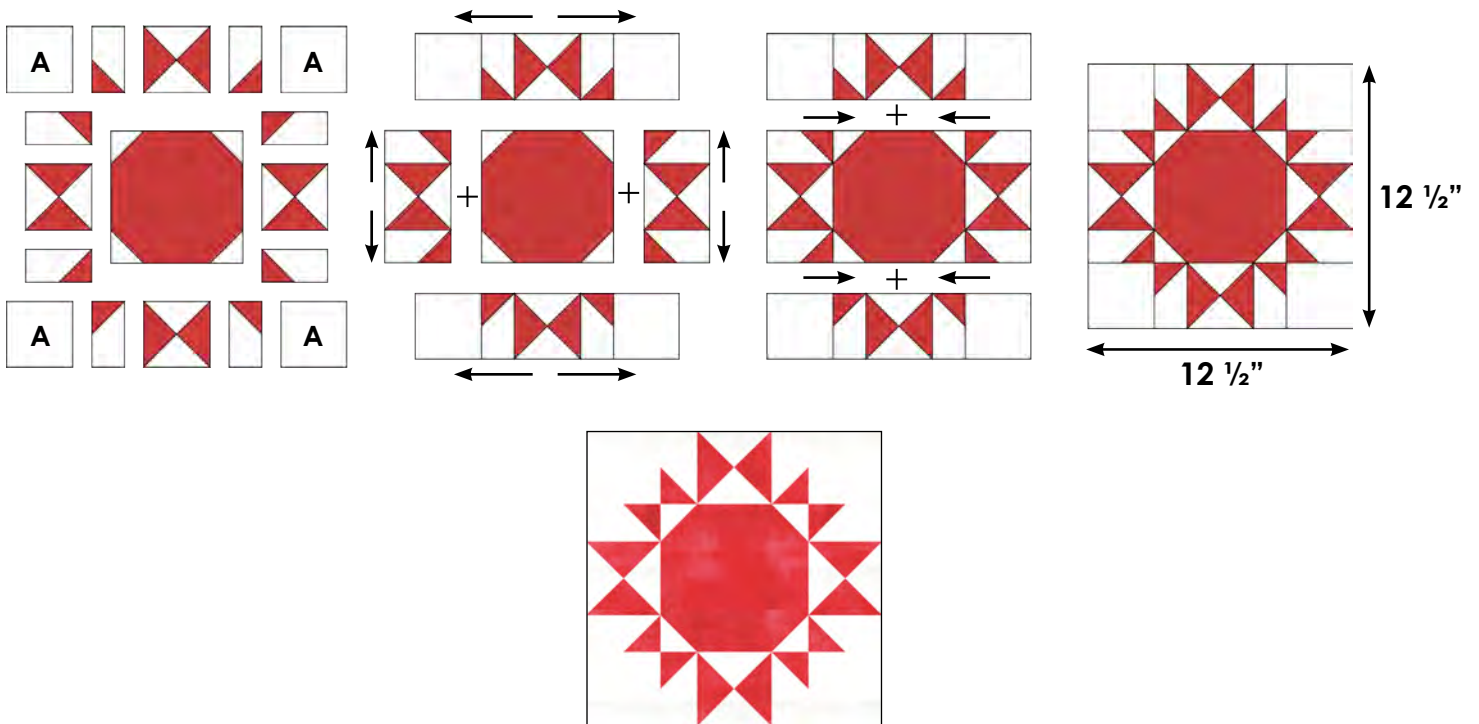

*Be sure to share your block and progress online!*

**#ModaStitchPink**





## Cutting

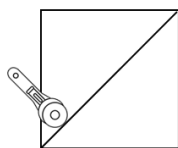
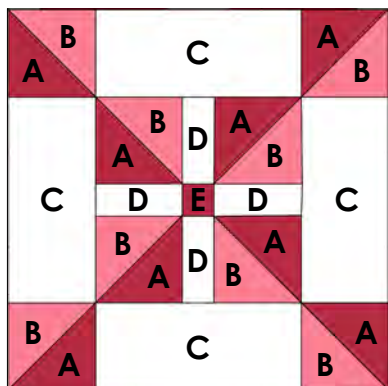

Cut Square Once Diagonally

<b>A</b>	(4) 3 5/8" squares; cut each square once diagonally to make (8) A triangles. <i>Grunge 30150-253</i>
<b>B</b>	(4) 3 5/8" squares; cut each square once diagonally to make (8) B triangles. <i>Grunge 30150-377</i>
<b>C</b>	(4) 3 1/4" x 7" rectangles. <i>Grunge 30150-101</i>
<b>D</b>	(4) 1 1/2" x 3 1/4" rectangles. <i>Grunge 30150-101</i>
<b>E</b>	(1) 1 1/2" square. <i>Grunge 30150-253</i>

## Assembly

1. Begin block assembly by making HST units. Place (1) A triangle and (1) B triangle right sides together and edges aligned.
2. Sew along the longest edge using a 1/4" seam. Press to the dark fabric.
3. Trim the HST unit to measure 3 1/4" x 3 1/4" unfinished.
4. Repeat to make (8) identical A/B HST units.
5. Make the block center using (4) A/B HST units, (4) D rectangles and (1) E square. Place units as shown.
6. Sew together in (3) horizontal rows, pressing all seams toward the D rectangles.
7. Sew horizontal rows together to complete the block center. Block center should measure 7" x 7" unfinished.

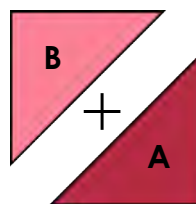

**Make (8)**

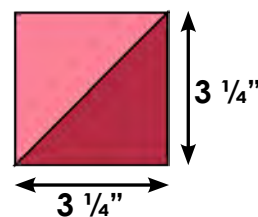

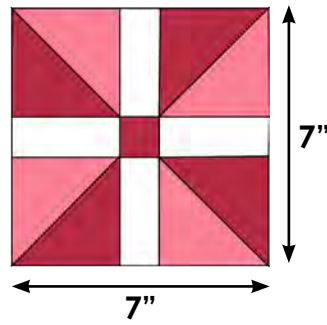
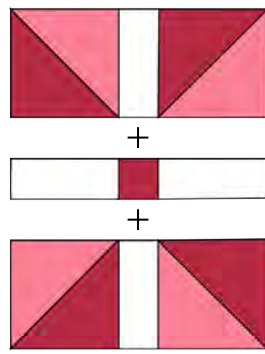
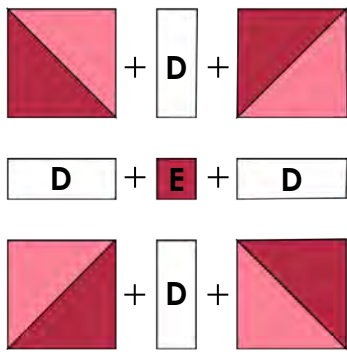

8. Continue block assembly by laying out the block center, the remaining A/B HST units and (4) C rectangles. Sew together as shown in the diagram. Press seams toward the C rectangles to complete. Block should measure 12 1/2" x 12 1/2" unfinished.

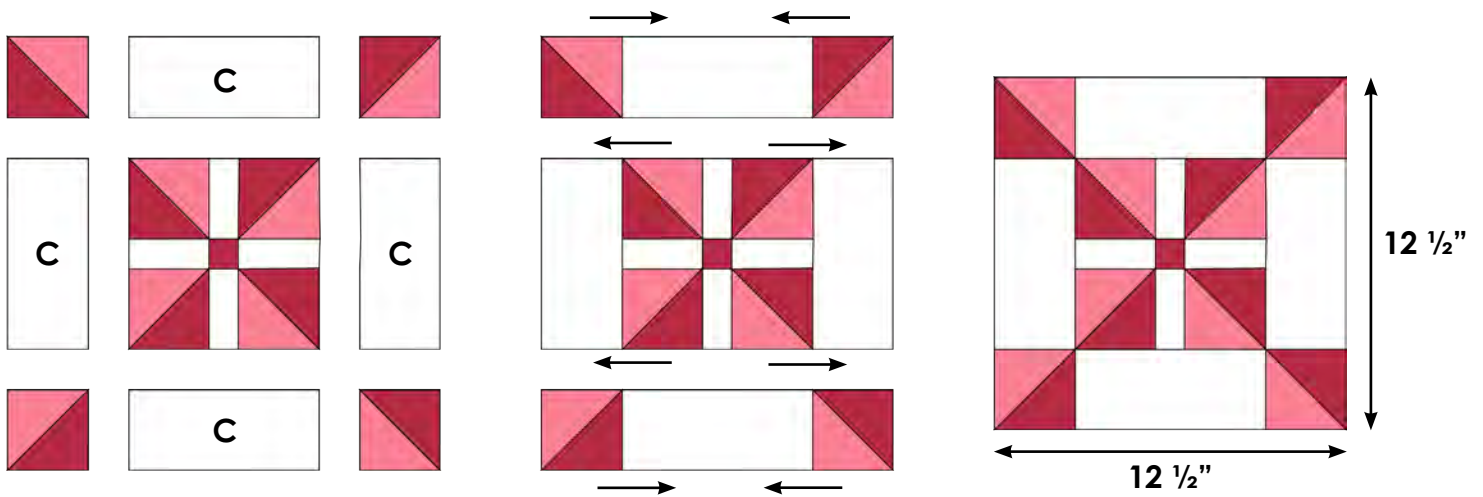

Be sure to share your block and progress online!

#ModaStitchPink



## Cutting

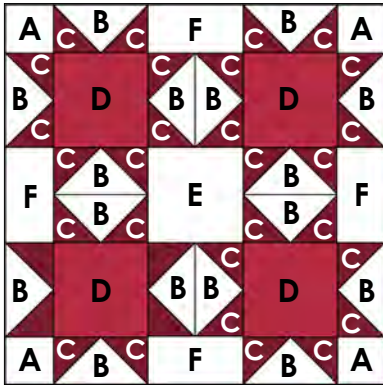

<b>A</b>	(4) 2" squares. <i>Grunge #30150 101</i>
<b>B</b>	(4) 4 ¼" squares; cut each square twice diagonally to make (16) B triangles. <i>Grunge #30150 101</i>
<b>C</b>	(16) 2 ⅜" squares; cut each square once diagonally to make (32) C triangles. <i>Grunge #30150 82</i>
<b>D</b>	(4) 3 ½" squares. <i>Grunge #30150 327</i>
<b>E</b>	(1) 3 ½" square. <i>Grunge #30150 101</i>
<b>F</b>	(4) 2" x 3 ½" rectangles. <i>Grunge #30150 101</i>

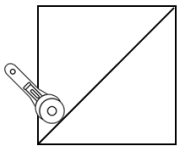

Cut Square Once Diagonally

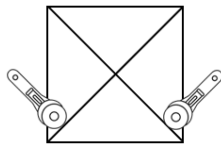

Cut Square Twice Diagonally

## Assembly

1. Begin block assembly by creating flying geese units. Place (1) C triangle on either side of (1) B triangle as shown.
2. Sew the C triangles to the B triangle one at a time using a scant ¼" seam. Press toward the corners.
3. Trim large flying geese units to measure 2" x 3 ½" unfinished. Repeat to make (16) identical flying geese units.

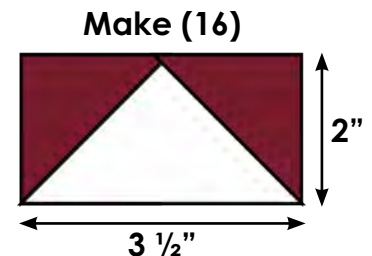
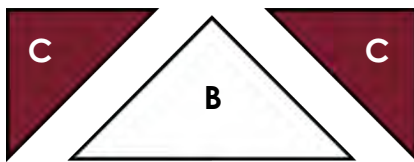

4. Continue block assembly by laying out all flying geese units, (4) A squares, (4) B rectangles, (4) D squares, (1) E square, and (4) F rectangles as shown. Begin assembling the block in (5) horizontal rows. Arrows indicate pressing instructions.
5. Sew all horizontal rows together to complete block assembly. Press. Block should measure 12 ½" x 12 ½" unfinished.

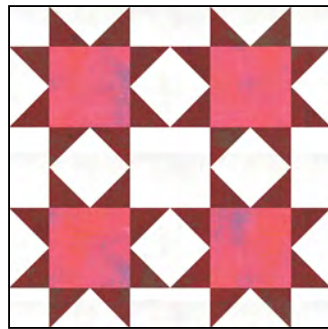
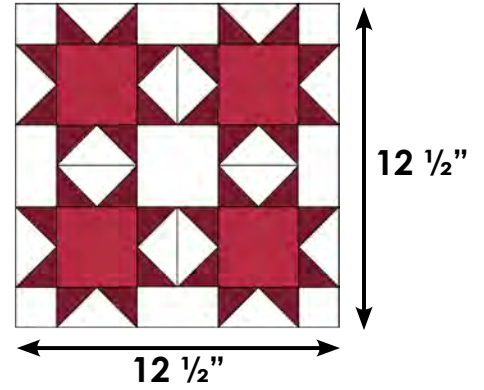
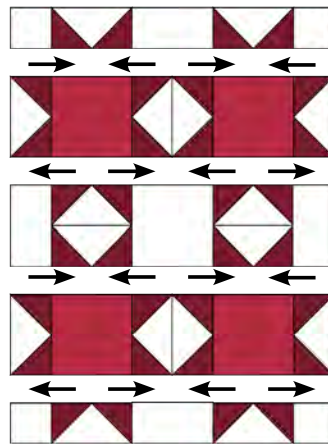
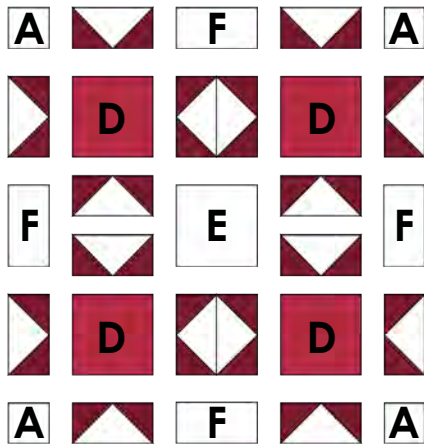

Be sure to share your block and progress online!

#ModaStitchPink



**PLEASE NOTE:** Lightweight fusible interfacing is required for this block.

## Cutting

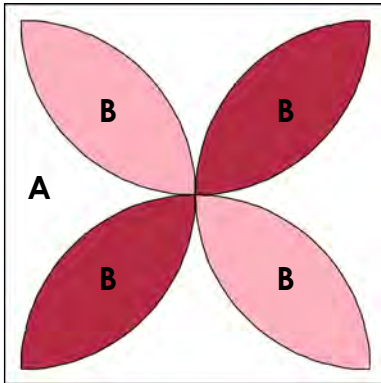

<b>A</b>	(1) 12 ½" x 12 ½" square. <i>Grunge #30150 101</i>
<b>B</b>	Set aside (4) assorted scraps for orange peels measuring at least 7" x 7". <i>Grunge 2- 253 and 377</i>
<p><b>Lightweight Fusible Interfacing:</b> Trace (4) orange peel templates onto the smooth side of the interfacing. Roughly cut out leaving at least ¼" for trimming.</p>	

## Assembly

1. Begin by placing (1) B scrap of fabric with (1) fusible interfacing orange peel template. The right side of fabric should be touching the glue side of the fusible interfacing template. Do not iron at this time. Pin in place to secure.
2. Sew on the traced line backstitching at the beginning and end of the seam to secure.
3. Cut out the orange peel a ¼" outside of the stitch line.
4. Use a small pair of scissors to carefully cut a small hole in the fusible interfacing. Do not cut through the fabric.
5. Pull the fabric through the hole carefully to bring the fabric right side out. The glue side of fusible interfacing should be visible.
6. Use an applique turning tool to smooth the edges of the orange peel. Carefully push the points of the orange peel for a crisp appearance.
7. Repeat to make (4) orange peels using flip and fuse methods.

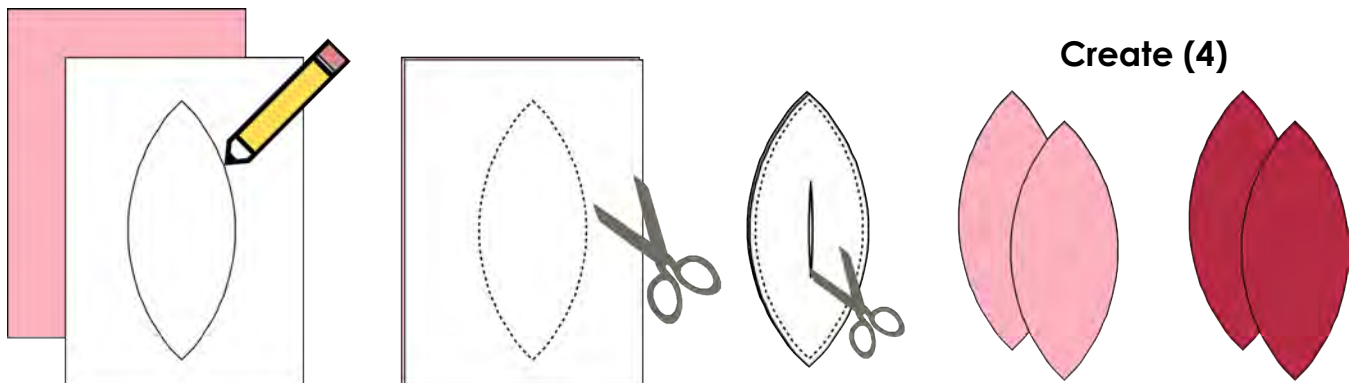

8. Fold the A square into quadrants (either horizontally or diagonally as shown below) and press to mark the exact center of the A square. This will help with even and balanced orange peel placement.
9. Arrange the orange peels onto the A square as shown. Fuse into place. Use pins if necessary.
10. Applique the orange peels into place using a thread color and decorative stitch of your choice.
11. Press to complete. Block should measure 12 1/2" x 12 1/2" unfinished.

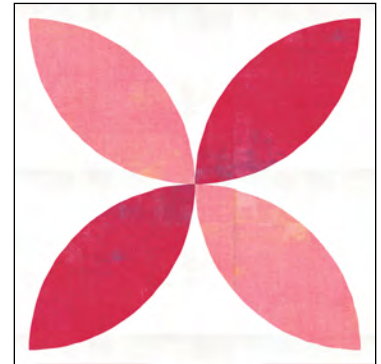
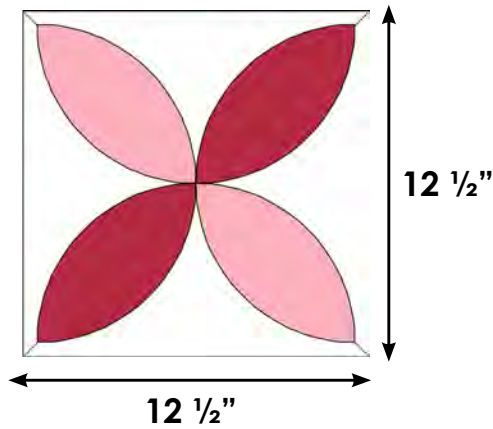
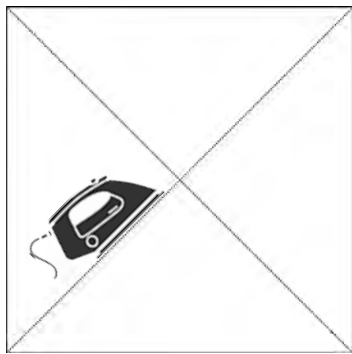

### Alternate Tropicana Setting

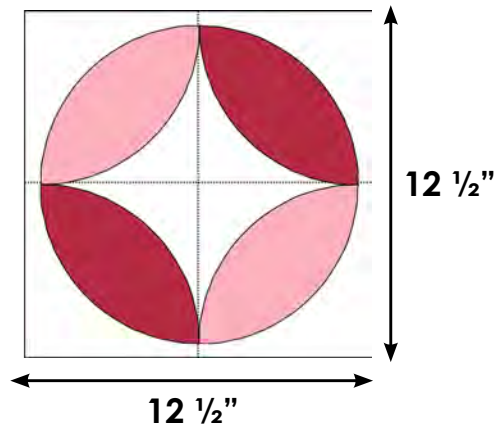
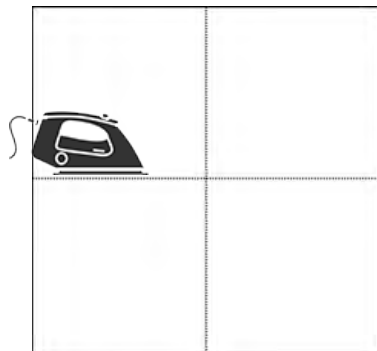



Block 19  
Tropicana

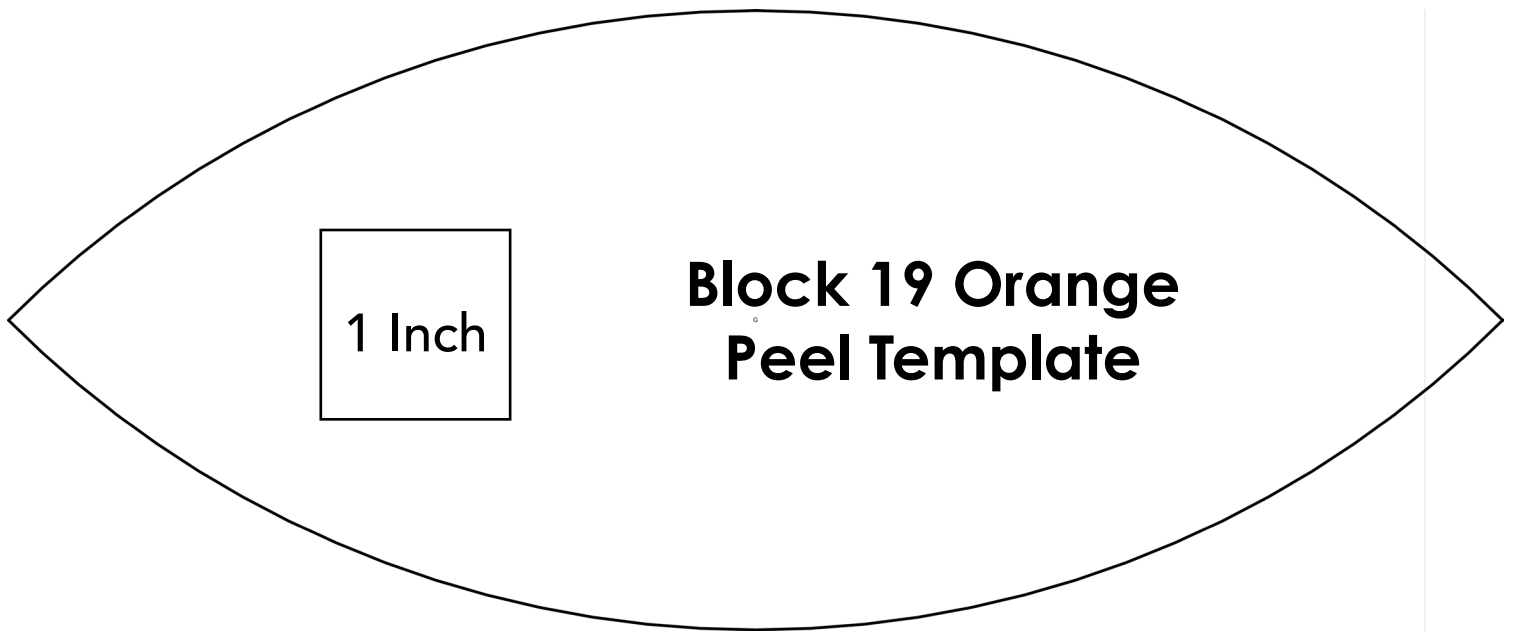

*Be sure to share your block and progress online!*

**#ModaStitchPink**



## Cutting

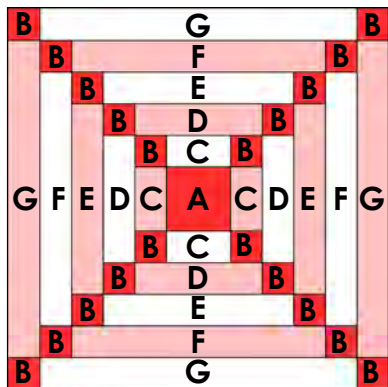

**PLEASE NOTE:** Cut pieces C-G are shown using (2) different fabrics. Determine how many fabrics you wish to use and adjust cutting accordingly.

<b>A</b>	(1) 2 ½" square. Grunge #30150 365
<b>B</b>	(20) 1 ½" squares. Grunge #30150 365
<b>C</b>	(4) 1 ½" x 2 ½" rectangles. Grunge 2 ea. of 101 and 64
<b>D</b>	(4) 1 ½" x 4 ½" rectangles. Grunge 2 ea. of 101 and 64
<b>E</b>	(4) 1 ½" x 6 ½" rectangles. Grunge 2 ea. of 101 and 64
<b>F</b>	(4) 1 ½" x 8 ½" rectangles. Grunge 2 ea. of 101 and 64
<b>G</b>	(4) 1 ½" x 10 ½" rectangles. Grunge 2 ea. of 101 and 64

## Assembly

1. Arrange A-B squares and C-G rectangles as shown in the diagrams.
2. Begin sewing the block together in layers, attaching rectangles to the block center in alphabetical order. For all layers, sew the side rectangles first. Then attach B squares to the top and bottom rectangles and sew. Press all seams toward the C-G rectangles and away from B squares.
3. Continue sewing until the block is complete. Block should measure 12 ½" x 12 ½" unfinished.

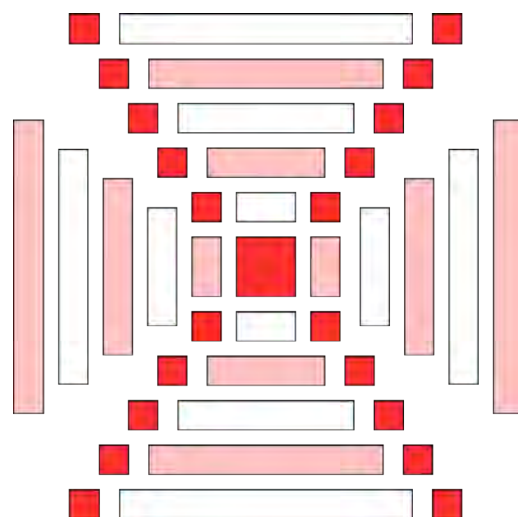



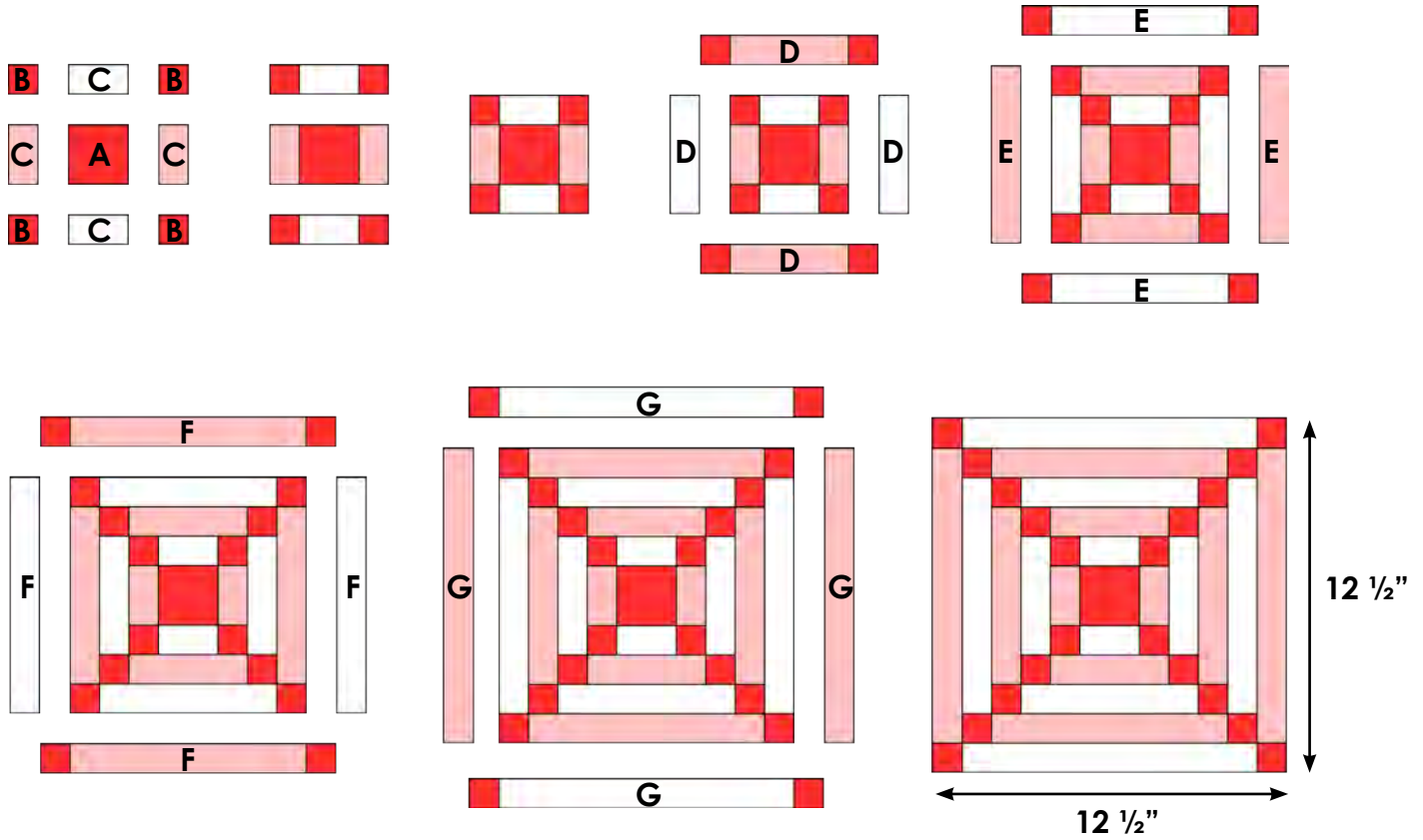

Be sure to share your block and progress online!

#ModaStitchPink



## Cutting

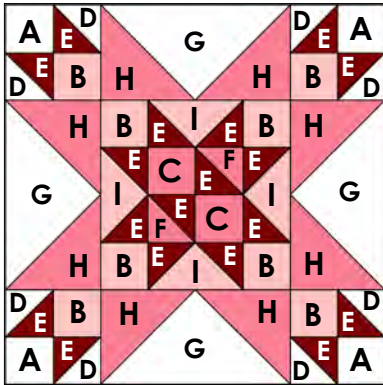

<b>A</b>	(4) 2" squares. <i>Grunge 30150-101</i>
<b>B</b>	(8) 2" squares. <i>Grunge 30150-64</i>
<b>C</b>	(2) 2" squares. <i>Grunge 30150-377</i>
<b>D</b>	(4) 2 3/8" squares; cut each square once diagonally to make (8) D triangles. <i>Grunge 30150-101</i>
<b>E</b>	(9) 2 3/8" squares; cut each square once diagonally to make (18) E triangles. <i>Grunge 30150-82</i>
<b>F</b>	(1) 2 3/8" square; cut the square once diagonally to make (2) F triangles. <i>Grunge 30150-377</i>
<b>G</b>	(1) 7 1/4" square; cut the square twice diagonally to make (4) G triangles. <i>Grunge 30150-101</i>
<b>H</b>	(4) 3 7/8" squares; cut each square once diagonally to make (8) H triangles. <i>Grunge 30150-377</i>
<b>I</b>	(1) 4 1/4" square; cut the square twice diagonally to make (4) I triangles. <i>Grunge 30150-64</i>

## Assembly

- Both small and large flying geese units are needed to create this block. Begin large flying geese unit assembly by placing (1) H triangle on either side of (1) G triangle as shown.
- Sew the H triangles to the G triangle one at a time using a scant 1/4" seam. Press toward the corners.
- Trim large flying geese units to measure 3 1/2" x 6 1/2" unfinished. Repeat to make (4) identical large flying geese units.

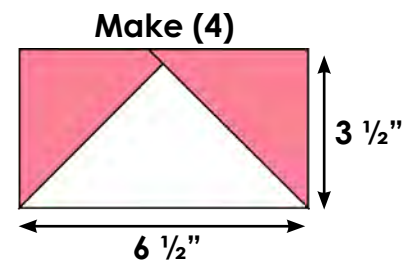
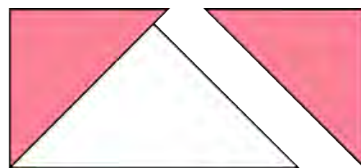
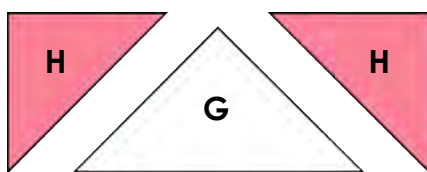

- Repeat flying geese unit assembly techniques to make small flying geese units. Gather (8) E triangles and (4) I triangles to make (4) identical small flying geese units measuring 2" x 3 1/2" unfinished.

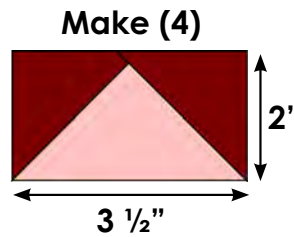
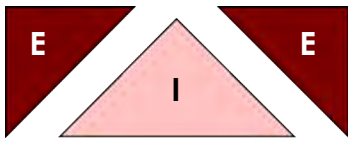

5. Make HST units using D and E triangles. Place (1) of each triangle right sides together and edges aligned.
6. Sew along the longest edge of the triangles using a  $\frac{1}{4}$ " seam.
7. Trim the HST unit to measure 2" x 2" unfinished. Press to the dark triangle.
8. Repeat HST unit assembly to make (8) D/E HST units and (2) E/F HST units. All HST units should measure 2" x 2" unfinished.

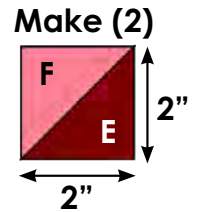
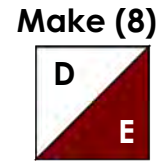
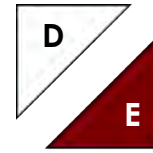

9. Make the block corner units using (2) D/E HST units, (1) A square and (1) B square. Place units as shown in the diagram.
10. Sew the 4-patch block corner unit together as shown, pressing toward the A and B squares.
11. Repeat to make (4) identical block corner units measuring  $3\frac{1}{2}$ " x  $3\frac{1}{2}$ " unfinished.
12. Using the same assembly methods described above for the block corner units, make the block center using (2) E/F HST units and (2) C squares. Block center should measure  $3\frac{1}{2}$ " x  $3\frac{1}{2}$ " unfinished.

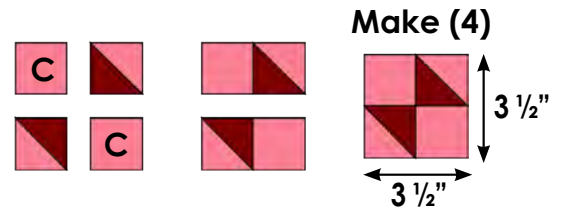
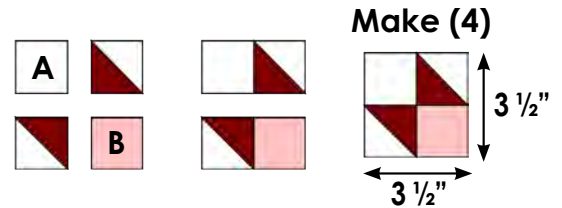

13. Make the star featured in the center of the block using (1) block center created in the above steps, (4) small flying geese units and (4) B squares.
14. Sew together as shown, pressing seams toward the B squares and the block center.
15. Press. Once complete, the star should measure  $6\frac{1}{2}$ " x  $6\frac{1}{2}$ " unfinished.

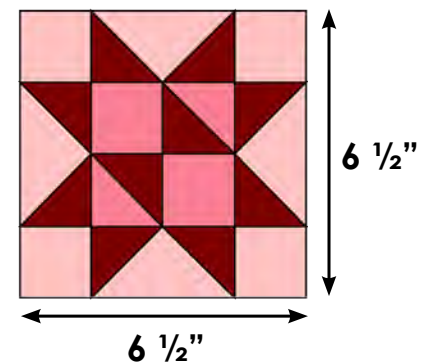
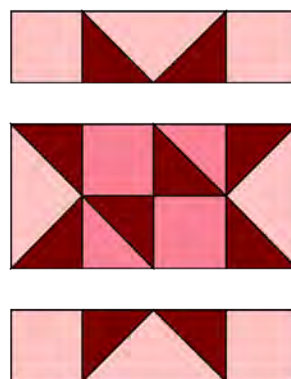
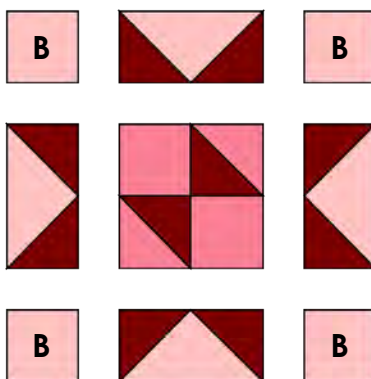



Block 21  
Celebrity

16. Complete block assembly by laying out the star, (4) large flying geese units and (4) block corner units as shown. Please note the placement of each block corner unit.
17. Sew together in (3) horizontal rows. Press seams away from the large flying geese units.
18. Sew horizontal rows together to complete the block. Press. The block should measure 12 1/2" x 12 1/2" unfinished.

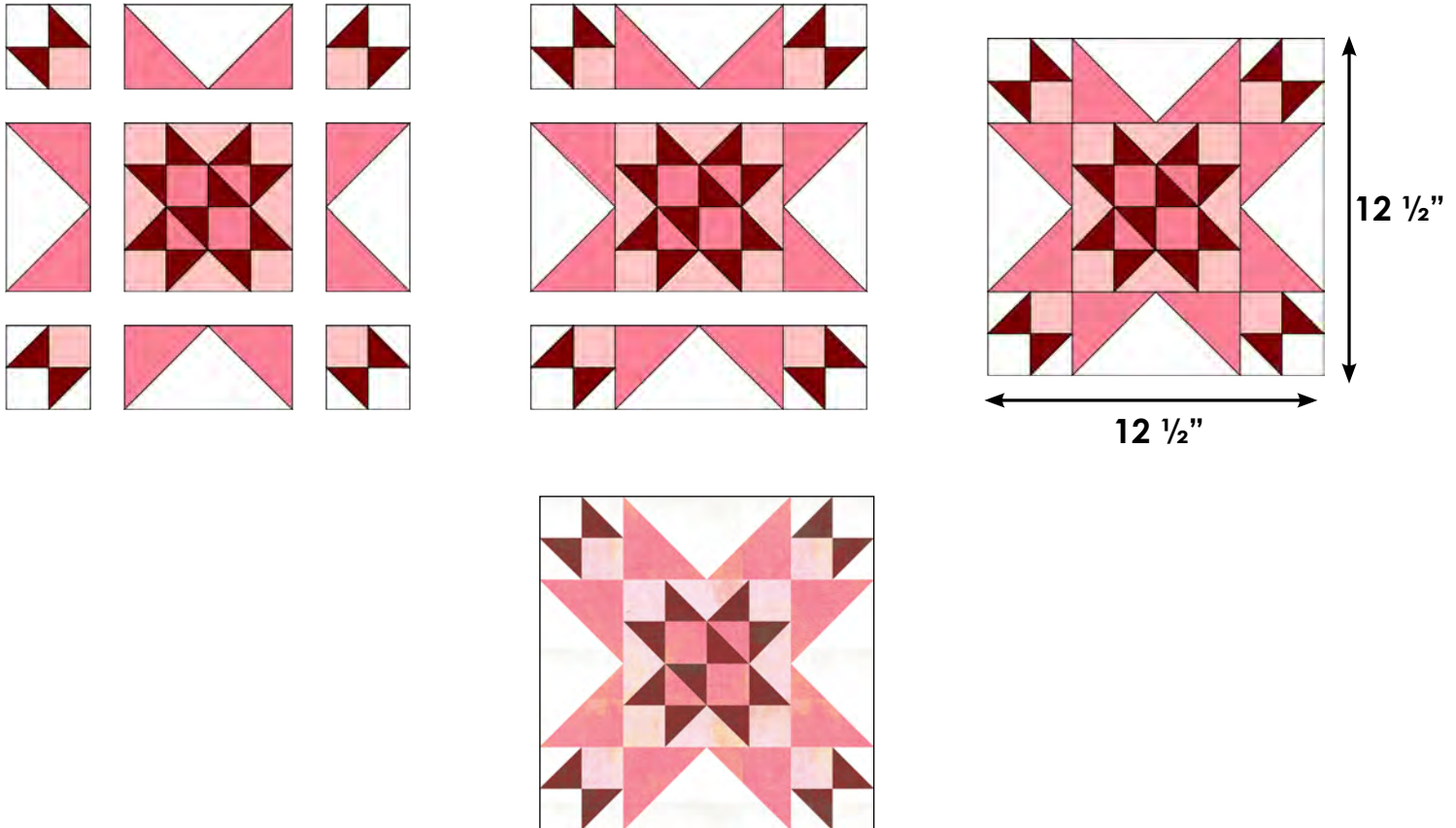

Be sure to share your block and progress online!

**#ModaStitchPink**



## Cutting

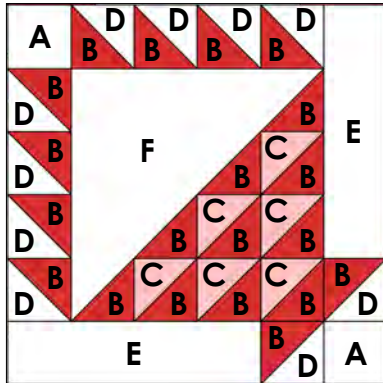

<b>A</b>	(2) 2 1/2" squares. <i>Grunge 30150-101</i>
<b>B</b>	(10) 2 7/8" squares; cut squares once diagonally to make (20) triangles. <i>Grunge 30150-365</i>
<b>C</b>	(3) 2 7/8" squares; cut each square once diagonally to make (6) C triangles. <i>Grunge 30150-64</i>
<b>D</b>	(5) 2 7/8" squares; cut each square once diagonally to make (10) D triangles. <i>Grunge 30150-101</i>
<b>E</b>	(2) 2 1/2" x 8 1/2" rectangles. <i>Grunge 30150-101</i>
<b>F</b>	(1) 8 7/8" square; cut the square once diagonally to make (2) F triangles. (Please note: (1) triangle will be unused.) <i>Grunge 30150-101</i>

## Assembly

1. Begin block assembly by creating HST units. Place (1) B triangle with (1) C triangle, right sides together and edges aligned.
2. Sew along the longest edge using a 1/4" seam.
3. Trim the HST unit to measure 2 1/2" x 2 1/2" unfinished. Press to the B triangle.
4. Using the HST unit assembly instructions, repeat to make (6) B/C HST units and (10) B/D HST units. All HST units should measure the same.
5. Make the block center using (6) B/C HST units, (4) B triangles and (1) F triangle. Sew together as shown. Arrows indicate pressing instructions. The block center should measure 8 1/2" x 8 1/2" unfinished.

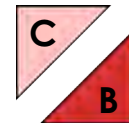

Make (6)

Make (10)

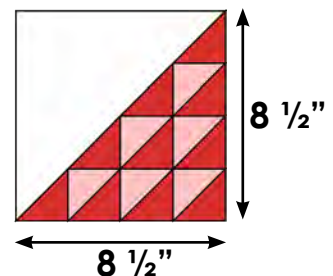
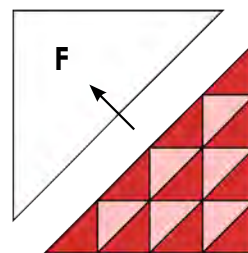
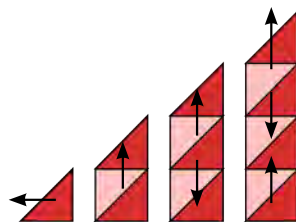
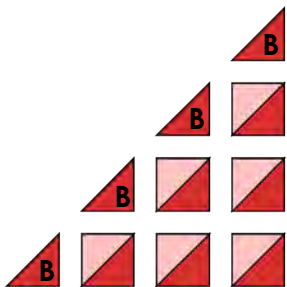
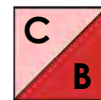

6. Place the remaining units around the block center as shown. Begin sewing the block together in stages following the diagrams for reference. Arrows indicate pressing instructions. Completed block should measure 12 1/2" x 12 1/2" unfinished.



Block 22

Something Special

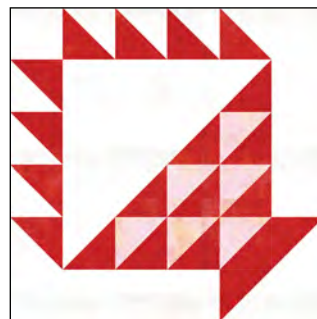
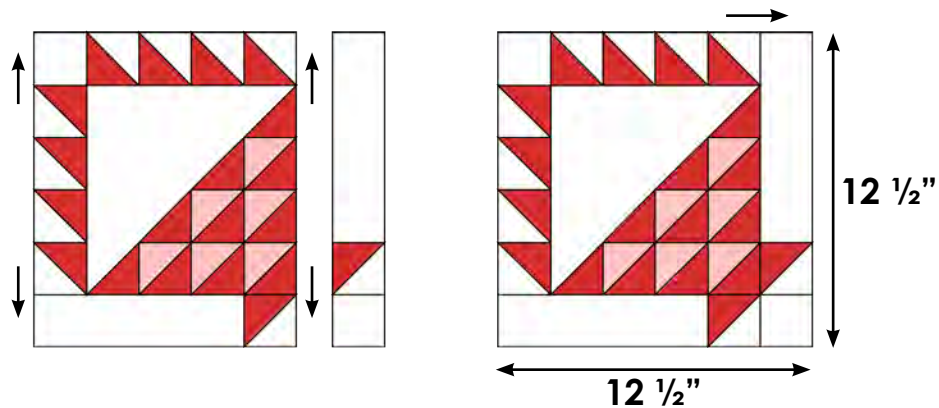
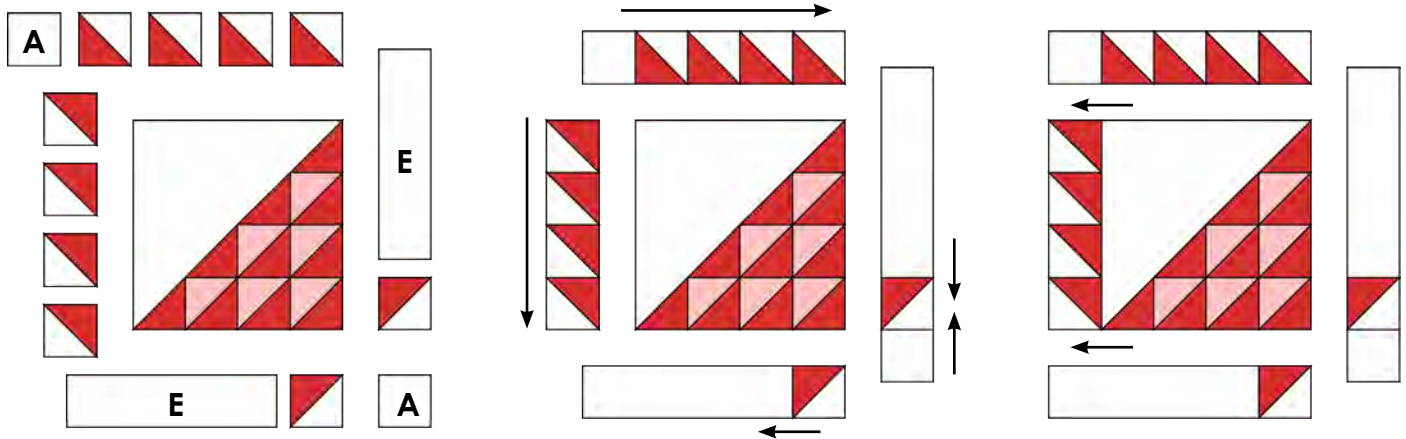

*Be sure to share your block and progress online!*

**#ModaStitchPink**



## Cutting

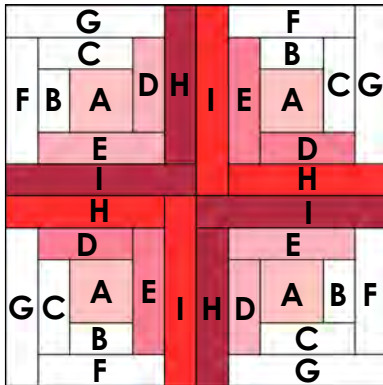

<b>A</b>	(4) 2 1/2" squares. <i>Grunge 30150-64</i>
<b>B</b>	(4) 1 1/2" x 2 1/2" rectangles. <i>Grunge 30150-101</i>
<b>C</b>	(4) 1 1/2" x 3 1/2" rectangles. <i>Grunge 30150-101</i>
<b>D</b>	(4) 1 1/2" x 3 1/2" rectangles. <i>Grunge 1- 325 &amp; 328, 2 of 377</i>
<b>E</b>	(4) 1 1/2" x 4 1/2" rectangles. <i>Grunge 1 325 &amp; 328, 2 of 377</i>
<b>F</b>	(4) 1 1/2" x 4 1/2" rectangles. <i>Grunge 30150-101</i>
<b>G</b>	(4) 1 1/2" x 5 1/2" rectangles. <i>Grunge 30150-101</i>
<b>H</b>	(4) 1 1/2" x 5 1/2" rectangles. <i>Grunge 1-325 &amp; 328, 2 of 254</i>
<b>I</b>	(4) 1 1/2" x 6 1/2" rectangles. <i>Grunge 1- 325 &amp; 328, 2 of 254</i>

## Assembly

1. The block is assembled in quadrants using log cabin piecing techniques to assemble the quadrants. Begin by laying out (1) of each A-I unit as shown.
2. Begin assembling the block by sewing layers onto the quadrant center beginning with the A square. Continue attaching layers in a clockwise formation. For all layers, press outward and away from the A square.
3. Repeat to make (4) quadrants measuring 6 1/2" x 6 1/2" unfinished.

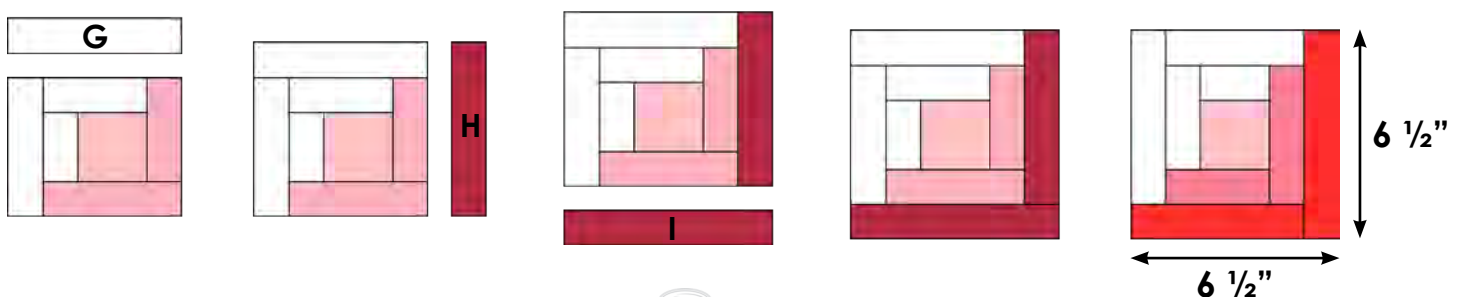
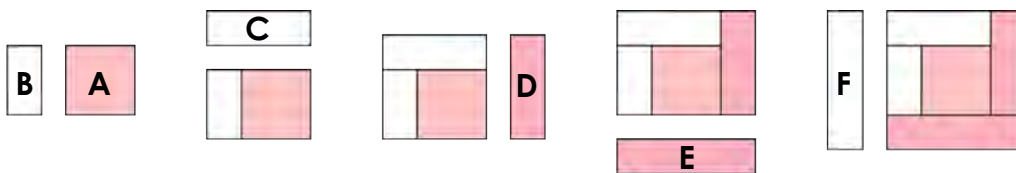

- Continue block assembly by laying out all (4) quadrants as shown. Each quadrant is turned a different direction.
- Sew quadrants together. Arrows indicate pressing instructions. Completed block should measure 12 1/2" x 12 1/2" unfinished.



Block 23  
Fixer Upper

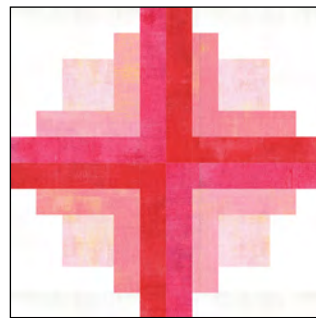
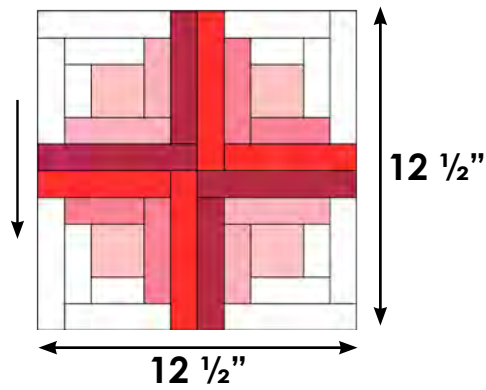
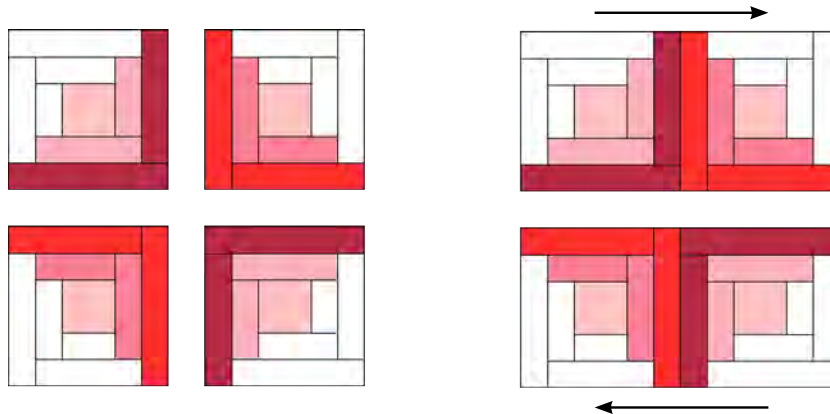

*Be sure to share your block and progress online!*

**#ModaStitchPink**





## Cutting

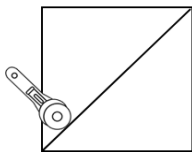
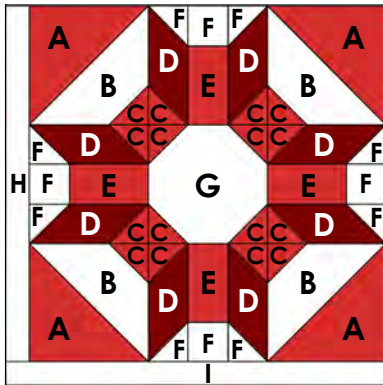

Cut Square Once Diagonally

<b>A</b>	(2) 4 5/8" squares; cut each square once diagonally to make (4) A triangles. <i>Grunge 30150-254</i>
<b>B</b>	(2) 4 5/8" squares; cut each square once diagonally to make (4) B triangles. <i>Grunge 30150-101</i>
<b>C</b>	(16) 1 3/4" squares; draw a diagonal line from corner to corner on the wrong side. <i>Grunge 30150-254</i>
<b>D</b>	(8) 1 3/4" x 4 1/4" rectangles. <i>Grunge 30150-82</i>
<b>E</b>	(4) 1 3/4" x 3" rectangles. <i>Grunge 30150-254</i>
<b>F</b>	(12) 1 3/4" squares; draw a diagonal line from corner to corner on the wrong side of (8) squares. Set the remaining squares aside. <i>Grunge 30150-101</i>
<b>G</b>	(1) 4 1/4" square. <i>Grunge 30150-101</i>
<b>H</b>	(1) 1 1/4" x 11 3/4" rectangle. <i>Grunge 30150-101</i>
<b>I</b>	(1) 1 1/4" x 12 1/2" rectangle. <i>Grunge 30150-101</i>

## Assembly

1. Begin block assembly by making HST units. Place (1) A triangle with (1) B triangle, right sides together and edges aligned.
2. Sew along the longest edge of the triangles using a 1/4" seam.
3. Trim the HST unit to measure 4 1/4" x 4 1/4" unfinished. Press to the A triangle.
4. Repeat to make (4) identical HST units.
5. Place (1) C square with a drawn diagonal line onto the "B" side of an HST unit, right sides together and edges aligned.
6. Sew along the drawn diagonal line.
7. Trim outermost excess fabric to 1/4" and press to the corner. Repeat stitch and flip techniques using the remaining HST units and (3) C squares.

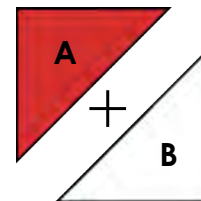

Make (4)

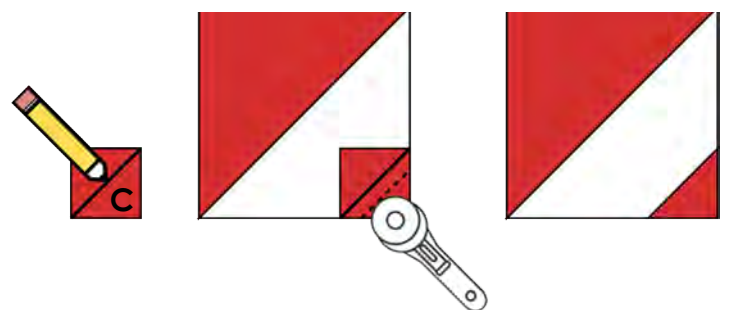
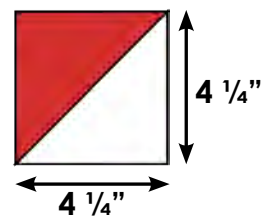

8. Using stitch and flip techniques described above, place (1) C square with a drawn diagonal line onto each corner of (1) G square. Stitch, flip and press. Set aside as the block center.

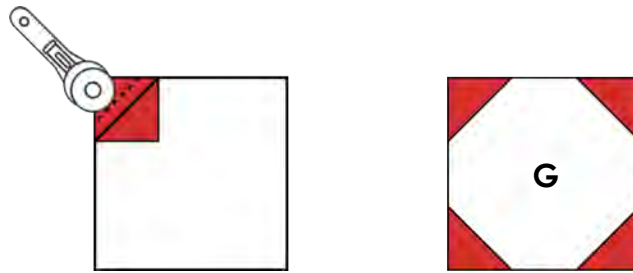

9. Using stitch and flip techniques described above, place (1) C square with a drawn diagonal line and (1) F square with a drawn diagonal line onto opposite ends of (1) D rectangle. Please note the orientation of the C and F squares.
10. Stitch, flip and press. Repeat to make (4) identical stitch and flip units using C, D and F units. Repeat to make (4) **mirror image** stitch and flip units using C, D and F units. Refer to diagrams for accurate fabric placement. Units should measure  $1\frac{3}{4}'' \times 4\frac{1}{4}''$  unfinished.

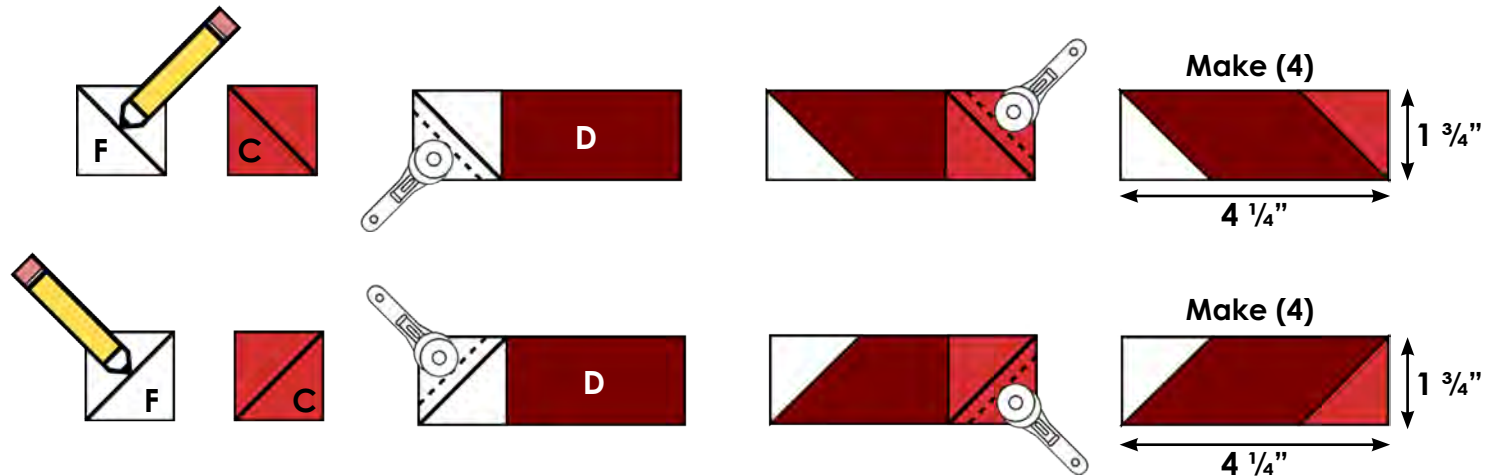

11. Sew (1) E rectangle to (1) F square as shown. Press toward the F rectangle.
12. Repeat to make (4) identical E/F units measuring  $1\frac{3}{4}'' \times 4\frac{1}{4}''$  unfinished.

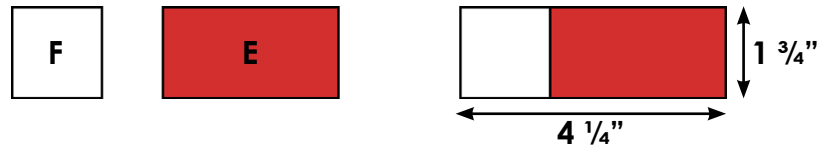

13. Lay out all units created in the above steps as shown. Please note the placement of mirror image stitch and flip units as well as the rotation of the HST units.
14. Sew together in rows. Arrows indicate pressing instructions, or press open to reduce bulk.
15. Sew rows together. Block should measure  $11\frac{3}{4}'' \times 11\frac{3}{4}''$  at this step.

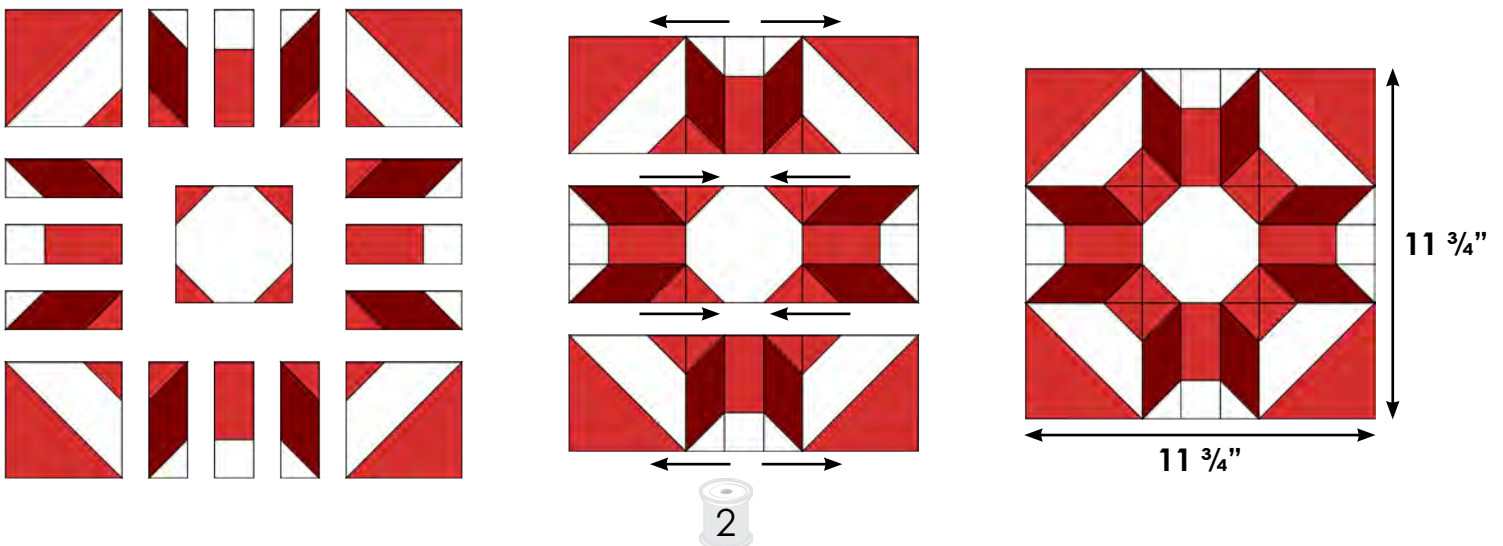

16. Sew (1) H rectangle to the left side of the block as shown. Press outward toward the H rectangle.
17. Sew (1) I rectangle to the bottom of the block as shown. Press outward toward the I rectangle to complete the block. Block should measure 12 1/2" x 12 1/2" unfinished.

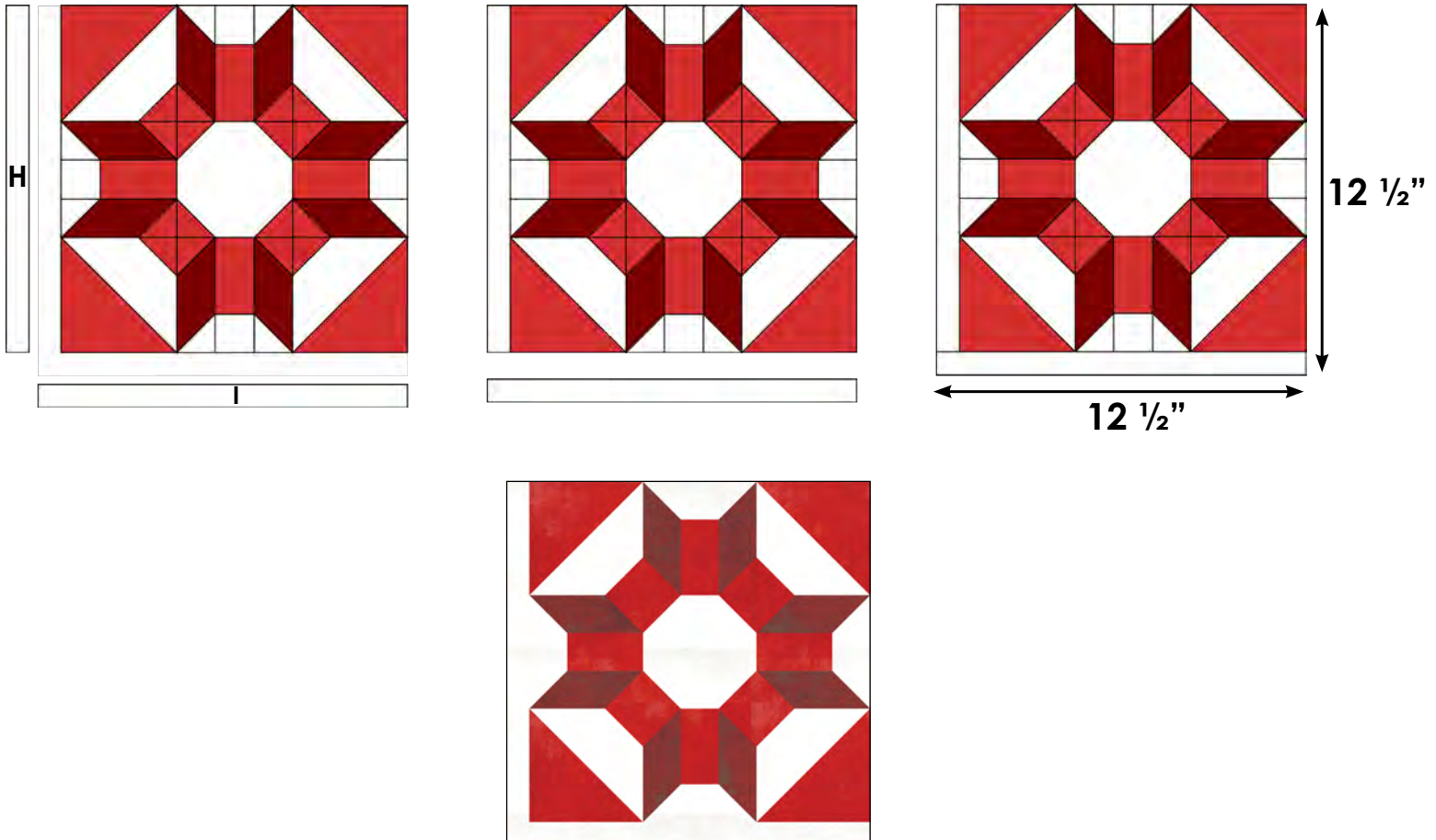

Be sure to share your block and progress online!

#ModaStitchPink



## Cutting

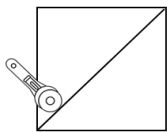
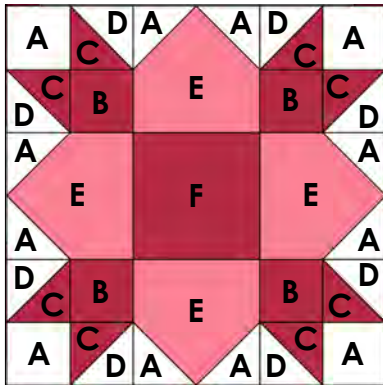

Cut Square Once Diagonally

<b>A</b>	(12) 2 1/2" squares; draw a diagonal line from corner to corner on the wrong side of (8) squares. Set the remaining squares aside. <i>Grunge 30150-101</i>
<b>B</b>	(4) 2 1/2" squares. <i>Grunge 30150-253</i>
<b>C</b>	(4) 2 7/8" squares; cut each square once diagonally to make (8) C triangles. <i>Grunge 30150-253</i>
<b>D</b>	(4) 2 7/8" squares; cut each square once diagonally to make (8) D triangles. <i>Grunge 30150-101</i>
<b>E</b>	(4) 4 1/2" squares. <i>Grunge 30150-325</i>
<b>F</b>	(1) 4 1/2" square. <i>Grunge 30150-253</i>

## Assembly

1. Begin block assembly by making HST units. Place (1) C triangle with (1) D triangle, right sides together and edges aligned.
2. Sew along the longest edge using a 1/4" seam.
3. Trim the HST unit to measure 2 1/2" x 2 1/2" unfinished. Press toward the C triangle.
4. Repeat to make (8) identical HST units.
5. Place (1) A square with a drawn diagonal line onto the top right corner of (1) E square as shown.
6. Sew along the drawn diagonal line.
7. Trim outermost excess fabric to 1/4" and press to the corner.
8. Repeat stitch and flip techniques on the top left corner of the E square to complete (1) stitch and flip unit. Unit should measure 4 1/2" x 4 1/2" unfinished.
9. Repeat to make (4) identical stitch and flip units using A and E squares.

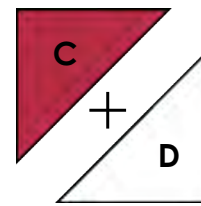

Make (8)

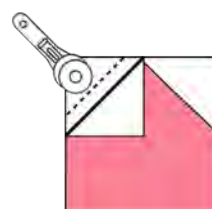
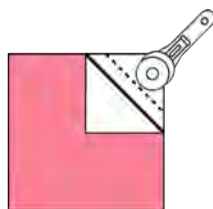
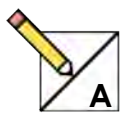
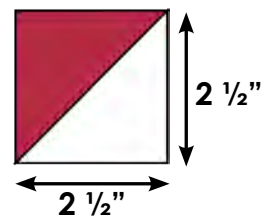

10. Continue block assembly by laying out HST units, stitch and flip units and the remaining cut fabric pieces A, B and F.
11. Sew the block together in (3) horizontal rows pressing towards the stitch and flip units in all rows.
12. Sew horizontal rows together to complete the block. Block should measure 12 1/2" x 12 1/2" unfinished.

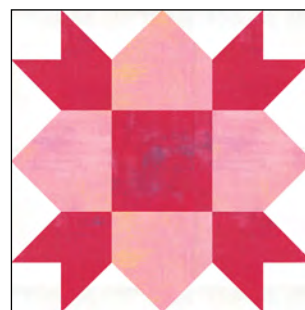
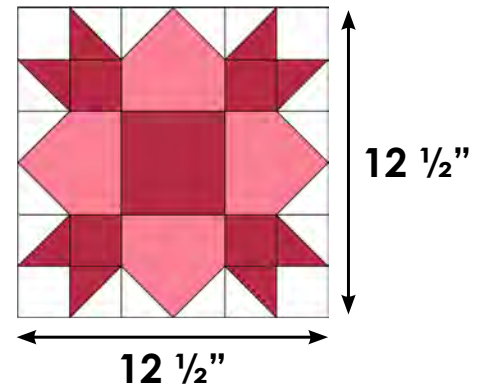
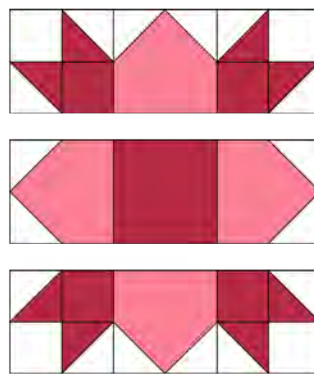
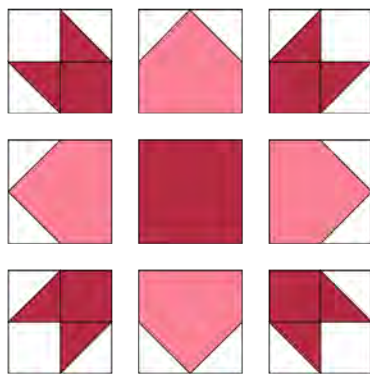
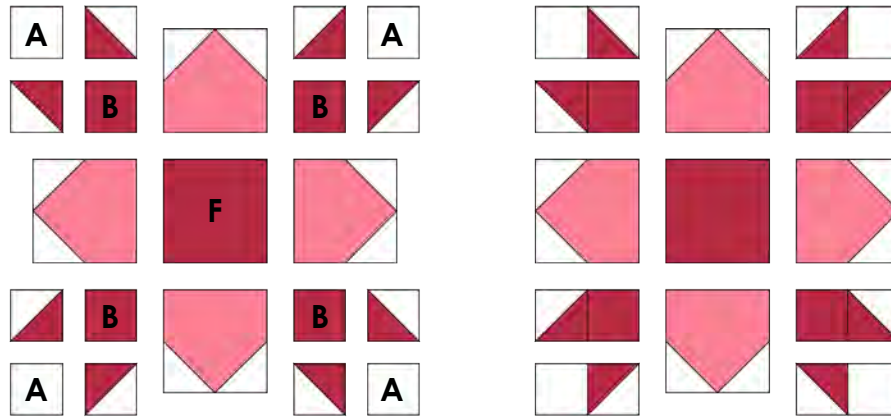

*Be sure to share your block and progress online!*  
**#ModaStitchPink**



## Cutting

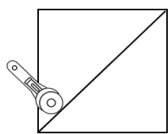
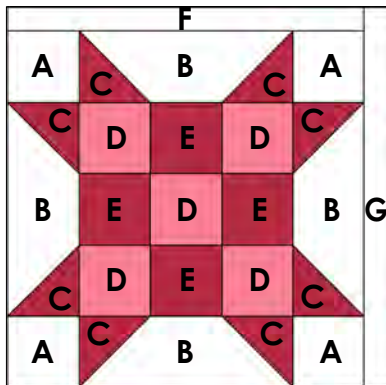

Cut Square Once Diagonally

<b>A</b>	(4) 2 <sup>3</sup> / <sub>4</sub> " squares. <i>Grunge 30150-101</i>
<b>B</b>	(4) 2 <sup>3</sup> / <sub>4</sub> " x 7 <sup>1</sup> / <sub>4</sub> " rectangles. <i>Grunge 30150-101</i>
<b>C</b>	(8) 2 <sup>3</sup> / <sub>4</sub> " squares; draw a diagonal line from corner to corner on the wrong side. <i>Grunge 30150-254</i>
<b>D</b>	(5) 2 <sup>3</sup> / <sub>4</sub> " squares. <i>Grunge 30150-325</i>
<b>E</b>	(4) 2 <sup>3</sup> / <sub>4</sub> " squares. <i>Grunge 30150-332</i>
<b>F</b>	(1) 1 <sup>1</sup> / <sub>4</sub> " x 11 <sup>3</sup> / <sub>4</sub> " rectangle. <i>Grunge 30150-101</i>
<b>G</b>	(1) 1 <sup>1</sup> / <sub>4</sub> " x 12 <sup>1</sup> / <sub>2</sub> " rectangle. <i>Grunge 30150-101</i>

## Assembly

1. Begin block assembly by creating stitch and flip units. Place (1) C square with a drawn diagonal line onto both ends of (1) B rectangle, right sides together and edges aligned. Diagrams show accurate C square orientation.
2. Sew along the drawn diagonal lines.
3. Trim outermost excess fabric to <sup>1</sup>/<sub>4</sub>" and press to the corner.
4. Repeat to make (4) identical stitch and flip units measuring 2 <sup>3</sup>/<sub>4</sub>" x 7 <sup>1</sup>/<sub>4</sub>" unfinished.

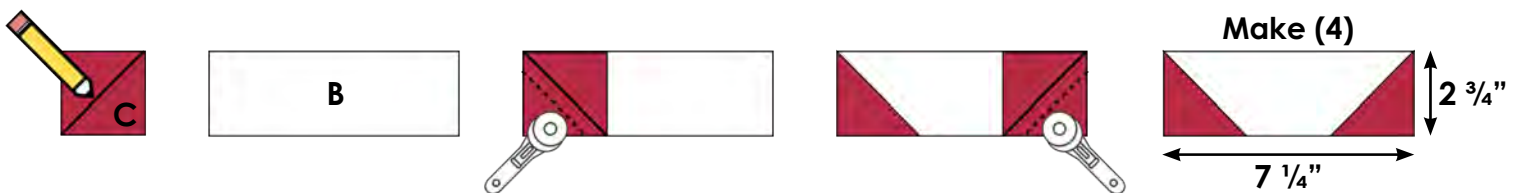

5. Begin laying out (4) stitch and flip units and the remaining cut pieces as shown. For the interior of the block, be sure to alternate between D and E squares.
6. Sew together as shown. Arrows indicate pressing instructions.
7. Press to complete. Block should measure 11 <sup>3</sup>/<sub>4</sub>" x 11 <sup>3</sup>/<sub>4</sub>" at this step.

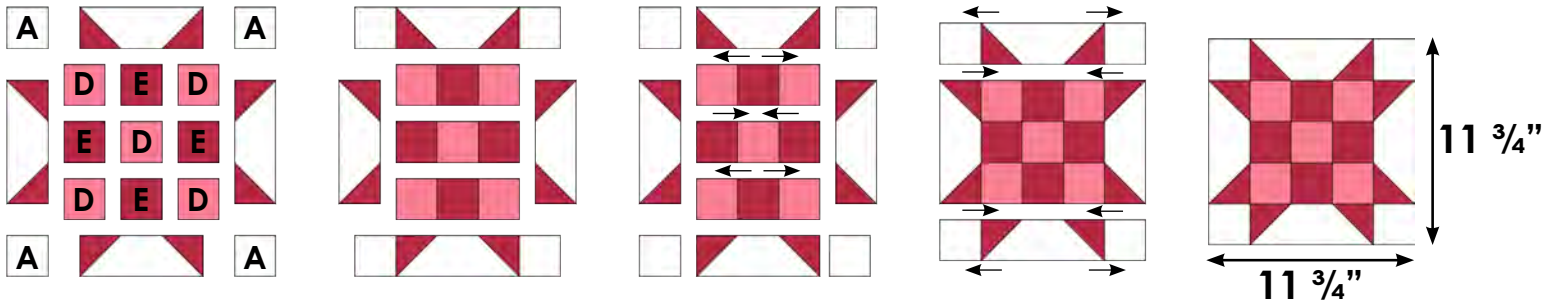

8. Sew (1) F rectangle to the top of the block. Press outward.
9. Sew (1) G rectangle to the right side of the block. Press outward to complete. Block should measure 12 1/2" x 12 1/2" unfinished.

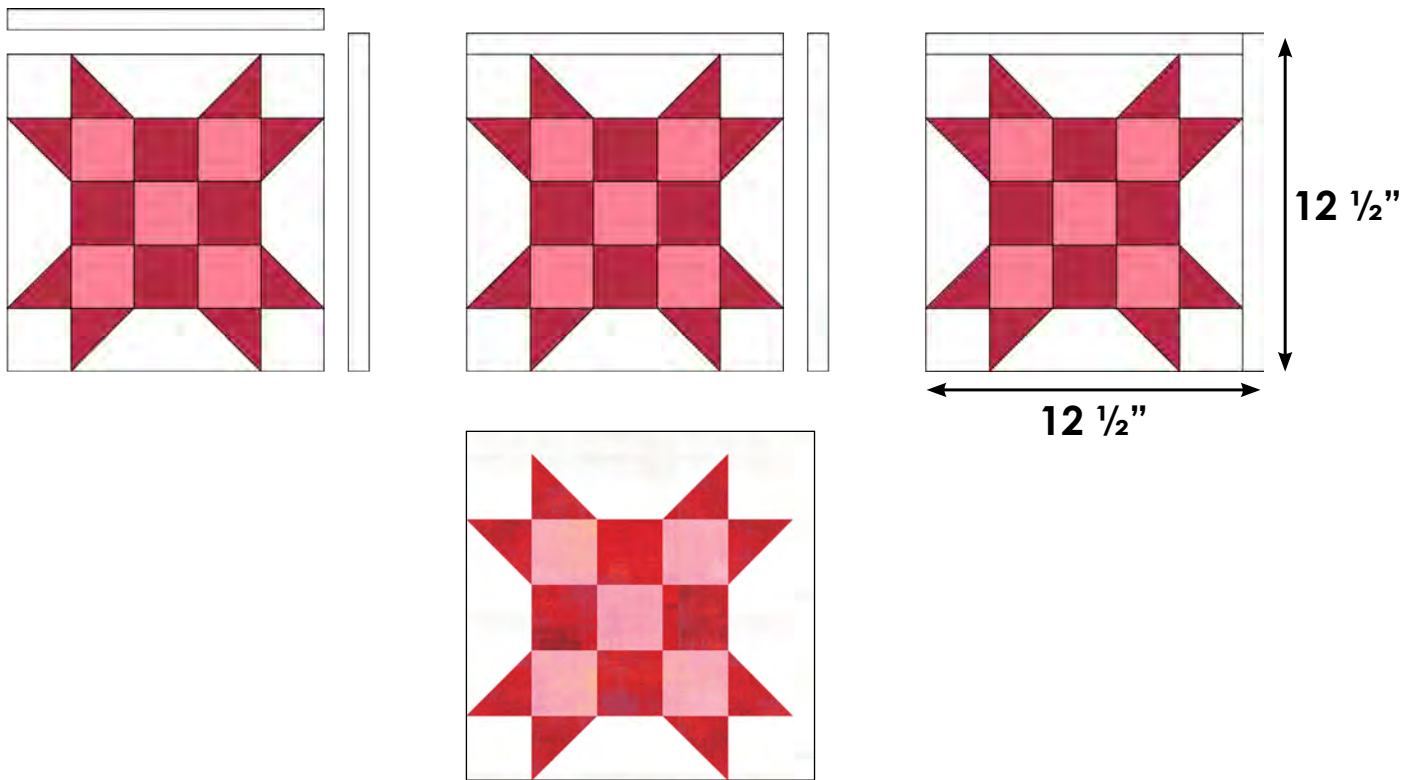

*Be sure to share your block and progress online!*

**#ModaStitchPink**



## Cutting

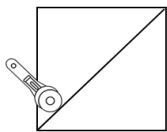
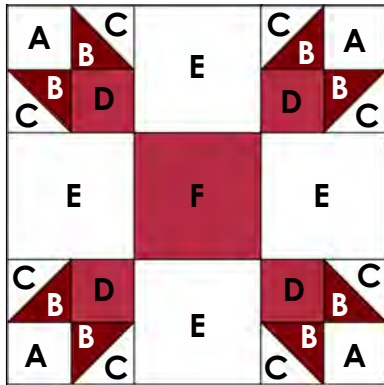

Cut Square Once Diagonally

<b>A</b>	(4) 2 1/2" squares. <i>Grunge 30150-101</i>
<b>B</b>	(4) 2 7/8" squares; cut each square once diagonally to make (8) B triangles. <i>Grunge 30150-82</i>
<b>C</b>	(4) 2 7/8" squares; cut each square once diagonally to make (8) C triangles. <i>Grunge 30150-101</i>
<b>D</b>	(4) 2 1/2" squares. <i>Grunge 30150-328</i>
<b>E</b>	(4) 4 1/2" squares. <i>Grunge 30150-101</i>
<b>F</b>	(1) 4 1/2" squares. <i>Grunge 30150-328</i>

## Assembly

1. Begin block assembly by creating HST units. Place (1) B triangle with (1) C triangle, right sides together and edges aligned.
2. Sew along the longest edge of the triangles using a 1/4" seam.
3. Trim the HST unit to measure 2 1/2" x 2 1/2" unfinished. Press to the dark fabric.
4. Repeat to make (8) identical HST units.
5. Make block corner units using (1) A square, (2) B/C HST units and (1) D square. Lay out and sew together as shown, pressing seams toward the A and D squares.
6. Repeat to make (4) block corner units measuring 4 1/2" x 4 1/2" unfinished.

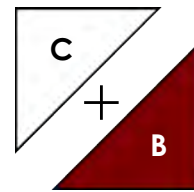

Make (8)

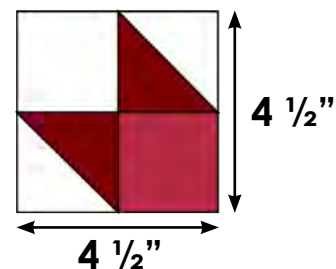
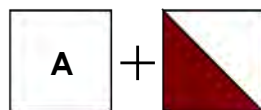
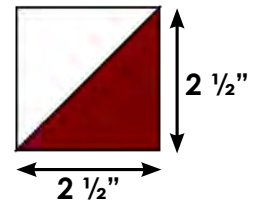



- Lay out (4) block corner units, (4) E squares and (1) F square as shown. Sew together in (3) rows. Press toward the E squares.
- Sew rows together. Press toward the center row to complete. Block should measure  $12\frac{1}{2}'' \times 12\frac{1}{2}''$  unfinished.

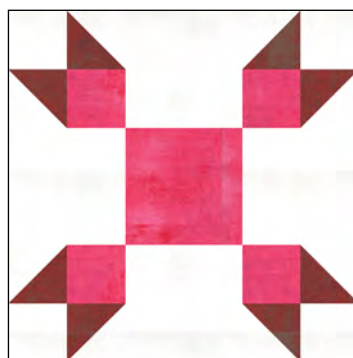
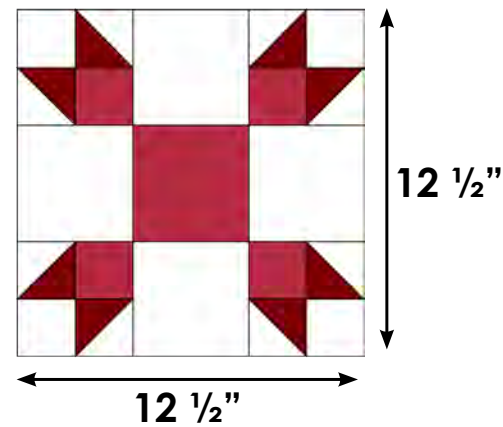
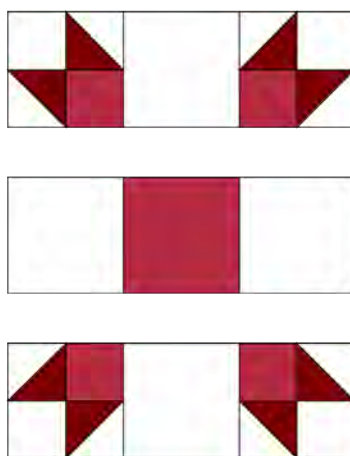
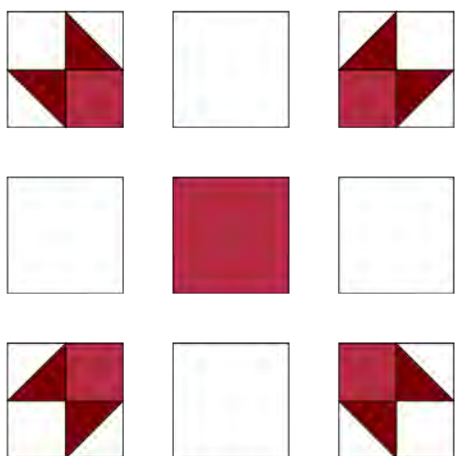

Be sure to share your block and progress online!

#ModaStitchPink

