



moda

Be My Neighbor

Block 1

18" x 18" finished

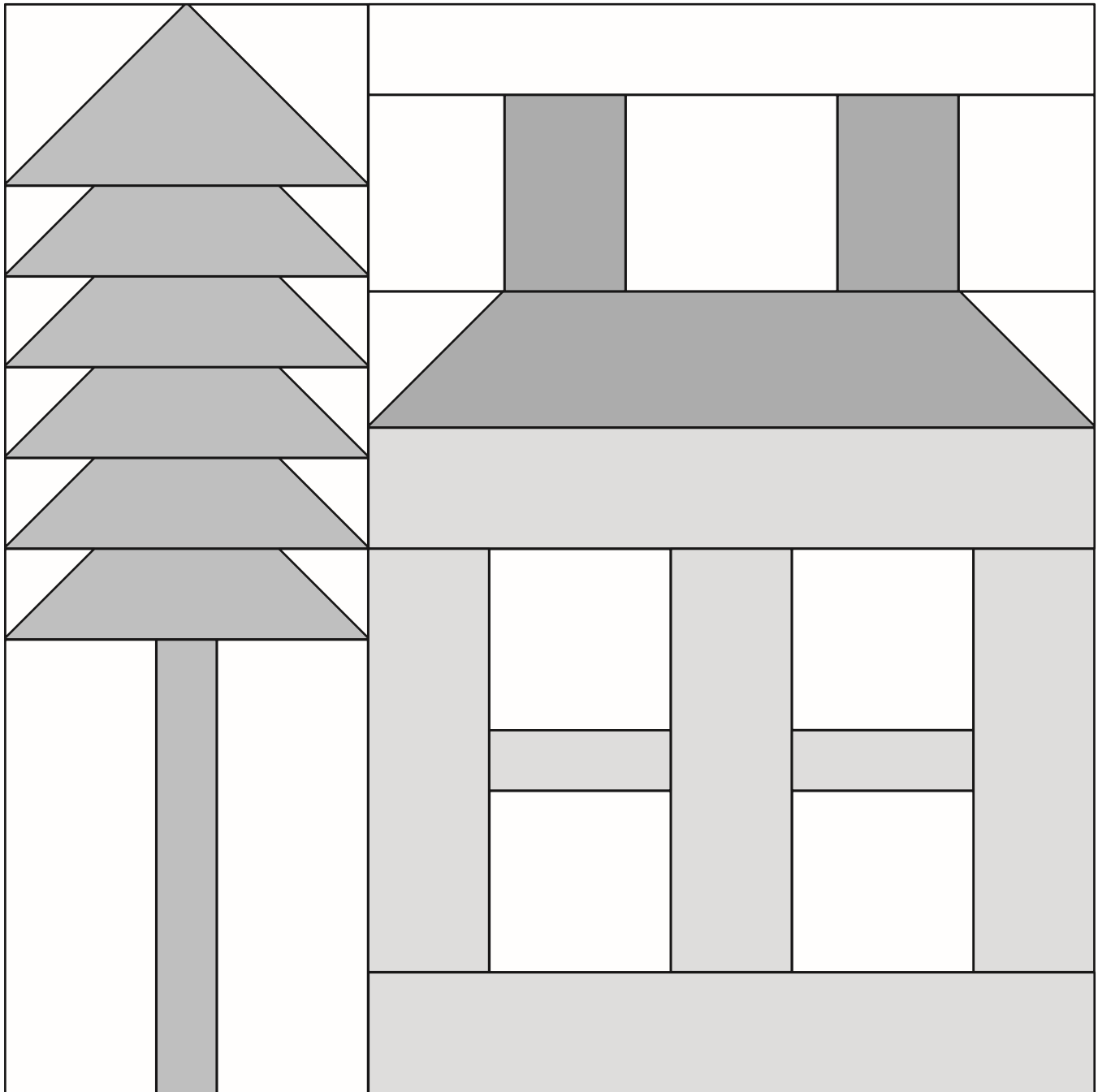

General Information

- These are very scrappy blocks. Mix your favorite Moda prints to create your colorful neighborhood!
- Share your progress and final quilt at #BeMyNeighbor. We love to see your results!!!

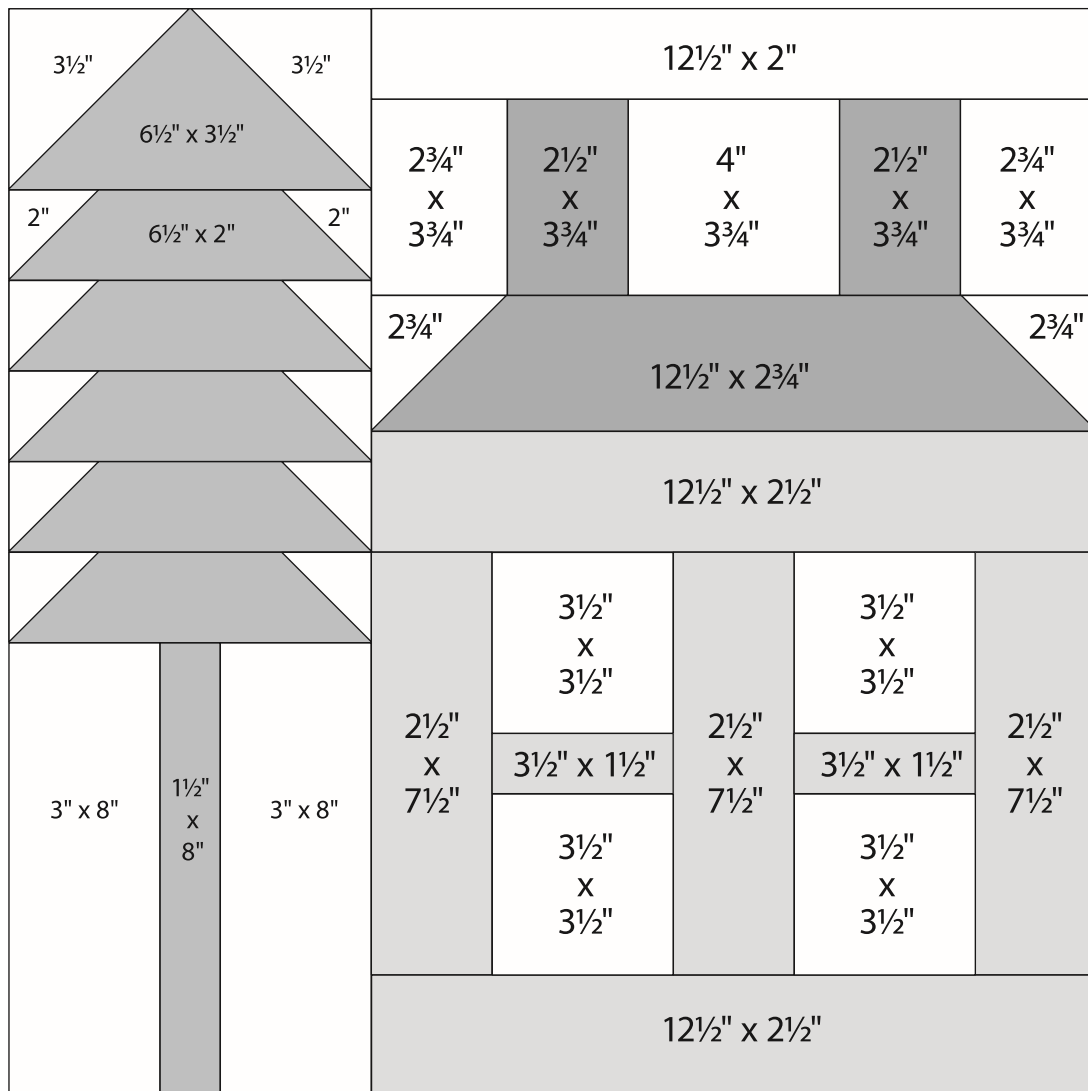

Block 1
18 $\frac{1}{2}$ " x 18 $\frac{1}{2}$ " unfinished

Cutting

House

- 2–12 $\frac{1}{2}$ " x 2 $\frac{1}{2}$ " rectangles
- 2–3 $\frac{1}{2}$ " x 1 $\frac{1}{2}$ " rectangles
- 3–2 $\frac{1}{2}$ " x 7 $\frac{1}{2}$ " rectangles

Windows

- 4–3 $\frac{1}{2}$ " squares

Roof and Chimneys

- 1–12 $\frac{1}{2}$ " x 2 $\frac{3}{4}$ " rectangle
- 2–2 $\frac{1}{2}$ " x 3 $\frac{3}{4}$ " rectangles

Tree

- 1–6 $\frac{1}{2}$ " x 3 $\frac{1}{2}$ " rectangle
- 5–6 $\frac{1}{2}$ " x 2" rectangles

Tree Trunk

- 1–1 $\frac{1}{2}$ " x 8" rectangle

Background

- 10–2" squares
- 1–2" x 12 $\frac{1}{2}$ " rectangle
- 2–2 $\frac{3}{4}$ " squares
- 2–2 $\frac{3}{4}$ " x 3 $\frac{3}{4}$ " rectangles
- 1–3 $\frac{3}{4}$ " x 4" rectangle
- 2–3" x 8" rectangles
- 2–3 $\frac{1}{2}$ " squares



moda Be My Neighbor

Block 1 is 18" x 18" finished.

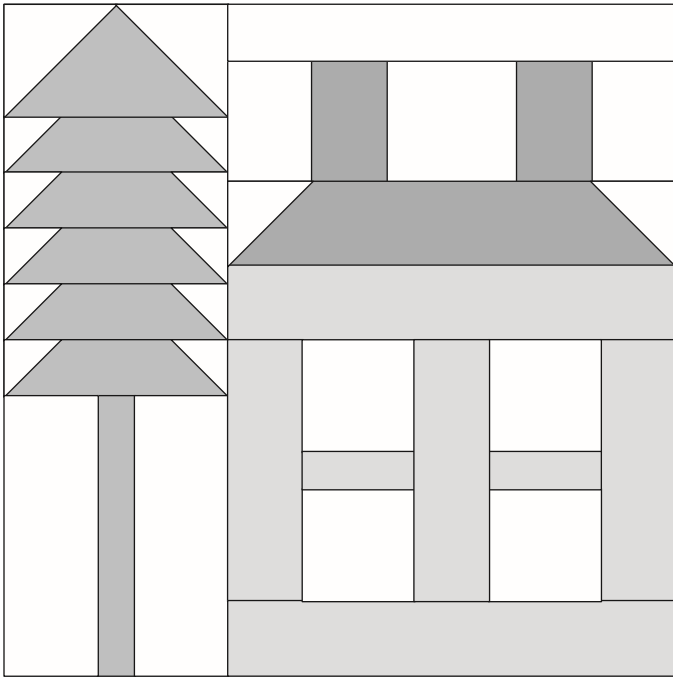

Construction

Use $\frac{1}{4}$ " seams. Press in the direction of the arrows in the diagrams.

1 Tree

(A) Draw a diagonal line from corner to corner on the wrong side of 2– $3\frac{1}{2}$ " background squares. Layer a $3\frac{1}{2}$ " marked background square, right sides together, on 1– $6\frac{1}{2}$ " x $3\frac{1}{2}$ " tree rectangle as shown. Sew on the diagonal line. Trim $\frac{1}{4}$ " from the sewn line. Press to reveal the triangle. Repeat on the opposite end of the same rectangle. Make 1.

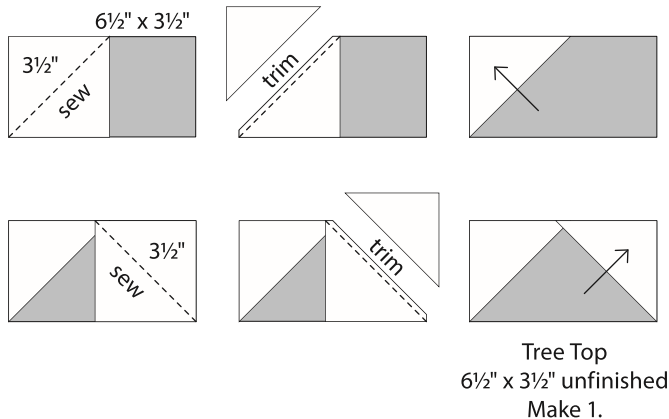

tree continued

(B) Draw a diagonal line from corner to corner on the wrong side of 10–2" background squares. Layer 2" marked background square, right sides together, on 1– $6\frac{1}{2}$ " x 2" tree rectangle as shown. Sew on the diagonal line. Trim $\frac{1}{4}$ " from the sewn line. Press to reveal the triangle. Repeat on the opposite end of the same rectangle. Make 5.

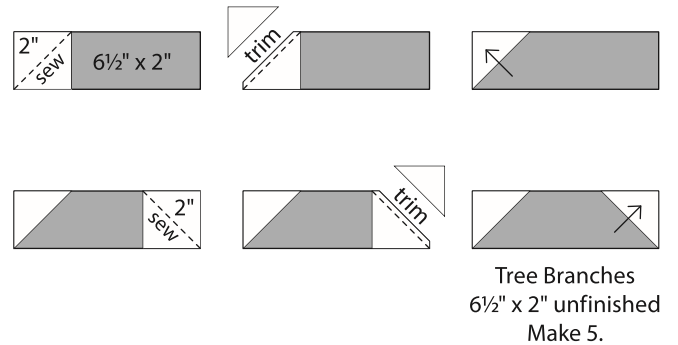

(C) Join 2–3" x 8" background and 1– $1\frac{1}{2}$ " x 8" tree trunk as shown. Make 1.

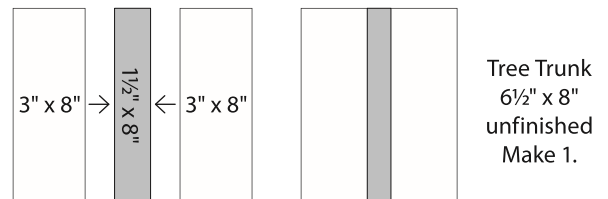

(D) Assemble the tree as shown.

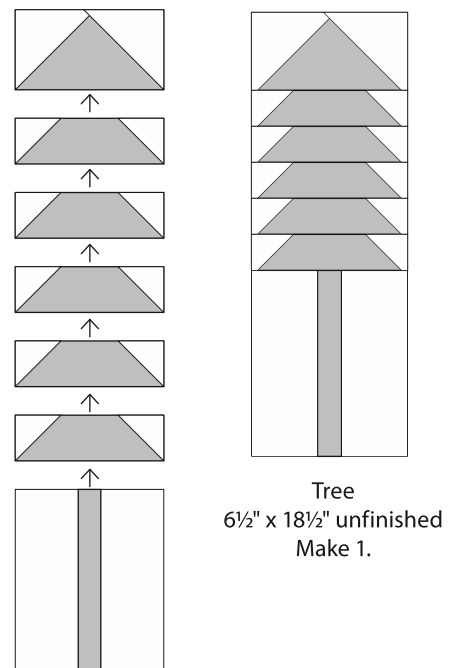

2 Chimney, Roof, and Windows

(A) Join 2- $2\frac{3}{4}$ " x $3\frac{3}{4}$ " backgrounds, 2- $2\frac{1}{2}$ " x $3\frac{3}{4}$ " chimneys, and 1-4" x $3\frac{3}{4}$ " background as shown to make the chimneys.

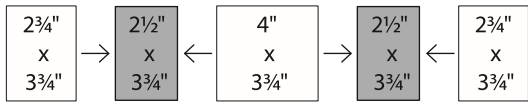

Chimneys
 $18\frac{1}{2}$ " x $3\frac{3}{4}$ " unfinished
Make 1.

(B) Draw a diagonal line from corner to corner on the wrong side of $2-2\frac{3}{4}$ " background squares. Layer a $2\frac{3}{4}$ " marked background square, right sides to together, on $1-12\frac{1}{2}$ " x $2\frac{3}{4}$ " roof rectangle as shown. Sew on the diagonal line. Trim $\frac{1}{4}$ " from the sewn line. Press to reveal the triangle. Repeat on the opposite end of the same rectangle.

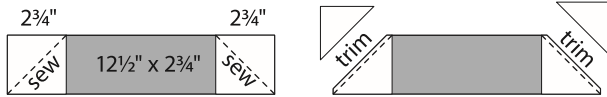

Roof
 $12\frac{1}{2}$ " x $2\frac{3}{4}$ " unfinished
Make 1.

(C) Assemble the windows as shown.

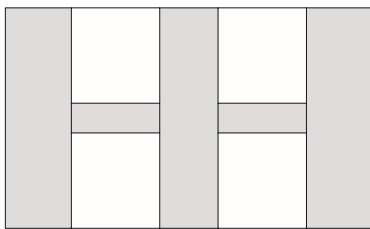
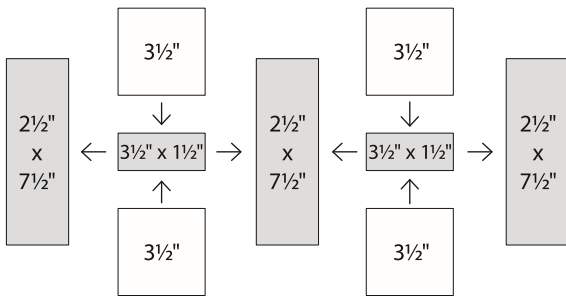

Window
 $12\frac{1}{2}$ " x $7\frac{1}{2}$ " unfinished
Make 1.

3 Assemble the house as shown.

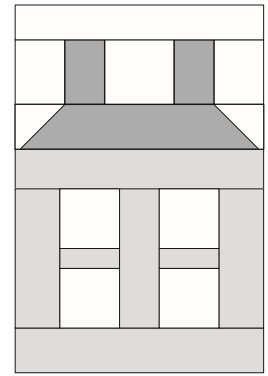
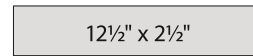
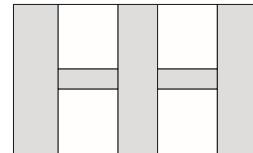
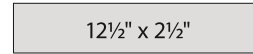
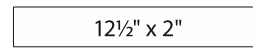

House
 $12\frac{1}{2}$ " x $18\frac{1}{2}$ " unfinished
Make 1.

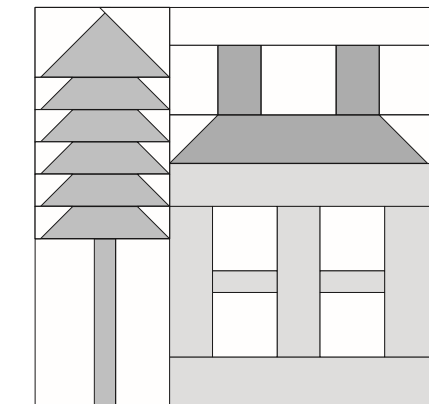
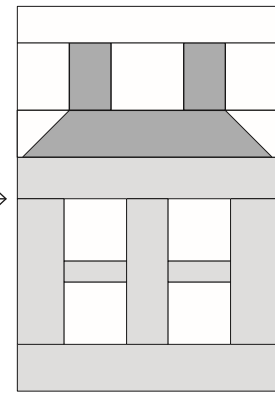
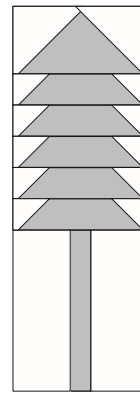

Block 1
 $18\frac{1}{2}$ " x $18\frac{1}{2}$ " unfinished.

moda

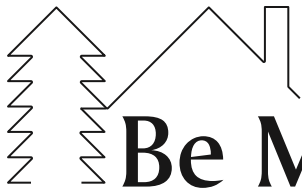

moda

Be My Neighbor

Block 2
15" x 18" finished

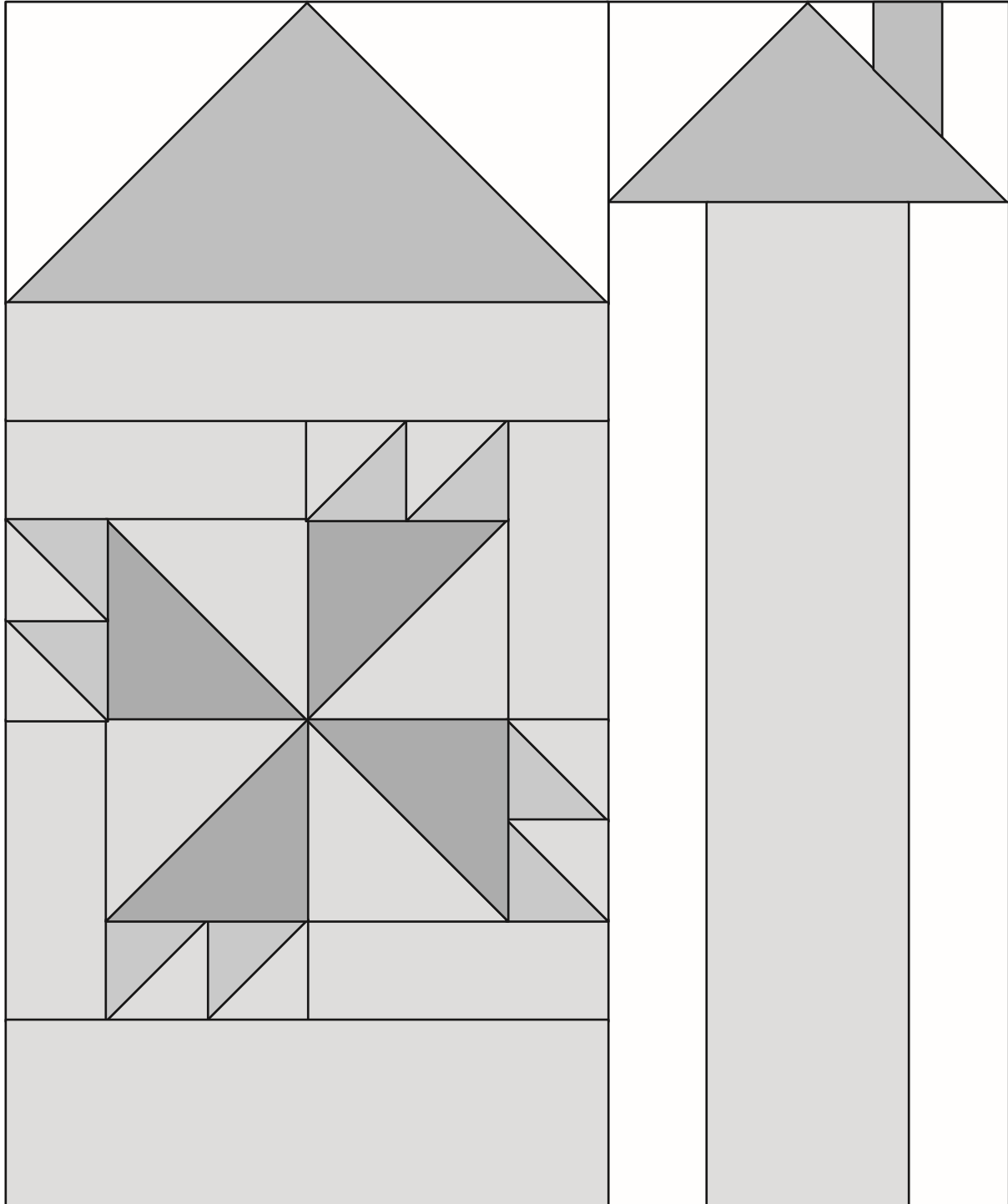

General Information

- These are very scrappy blocks. Mix your favorite Moda prints to create your colorful neighborhood!
- Share your progress and final quilt at #BeMyNeighbor. We love to see your results!!!

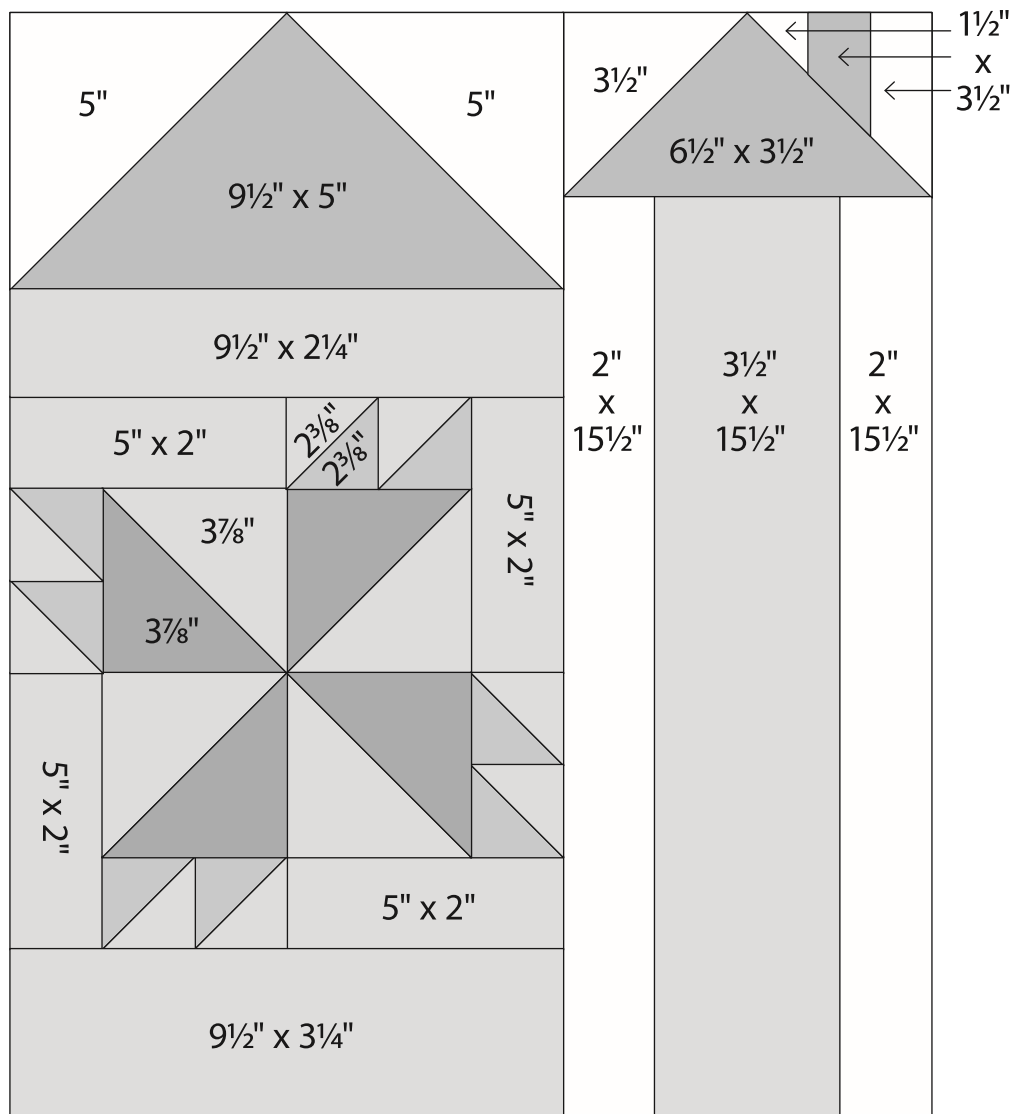

Block 2
15 1/2" x 18 1/2" unfinished

Cutting

House

- 1-9 1/2" x 3 1/4" rectangle
- 1-9 1/2" x 2 1/4" rectangle
- 4-5" x 2" rectangles
- 2-3 7/8" squares
 - cut in half once on the diagonal to make 4 half-square triangles
- 4-2 3/8" squares
 - cut in half once on the diagonal to make 8 half-square triangles

House Roof

- 1-9 1/2" x 5" rectangle

Pinwheel

- 2-3 7/8" squares
 - cut in half once on the diagonal to make 4 half-square triangles

Pinwheel Points

- 4-2 3/8" squares
 - cut in half once on the diagonal to make 8 half-square triangles

Tower

- 1-3 1/2" x 15 1/2" rectangle

Tower Roof

- 1-6 1/2" x 3 1/2" rectangle

Tower Chimney

- 1-3 1/2" x 1 1/2" rectangle

Background

- 2-5" squares
- 1-3 1/2" square
- 2-3 1/2" x 1 1/2" rectangles
- 2-2" x 15 1/2" rectangles



Be My Neighbor

moda

Block 2 is 15" x 18" finished.

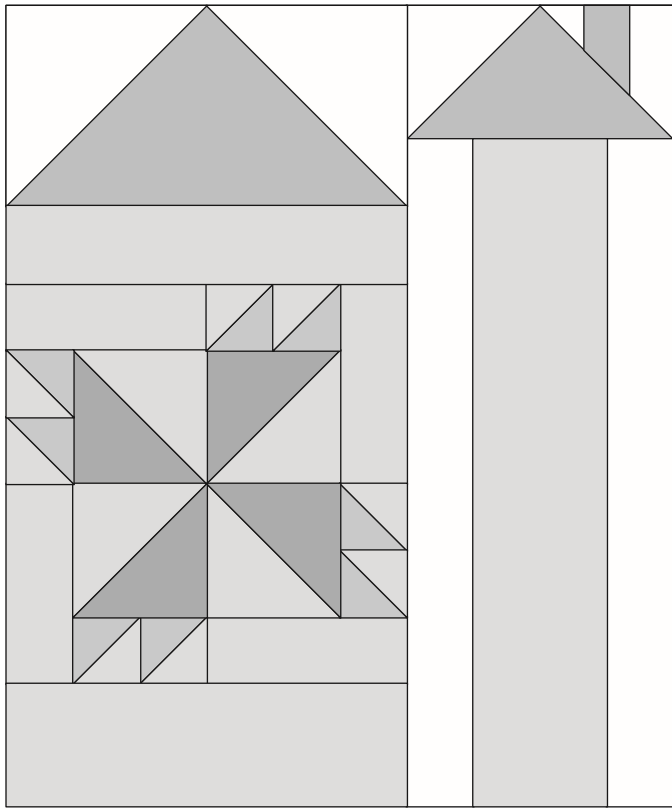

Construction

Use $\frac{1}{4}$ " seams. Press in the direction of the arrows in the diagrams.

1 House Roof

Draw a diagonal line from corner to corner on the wrong side of 2–5" background squares. Layer a 5" marked background square, right sides to together, on 1–9½" x 5" roof rectangle as shown. Sew on the diagonal line. Trim $\frac{1}{4}$ " from the sewn line. Press to reveal the triangle. Repeat on the opposite end of the same rectangle. Make 1.

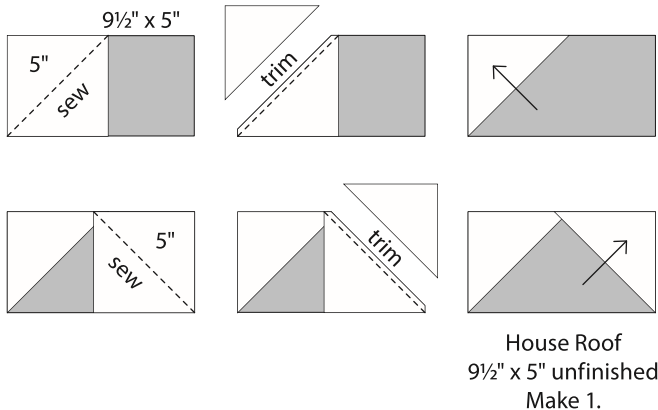

2 Pinwheel with points

(A) Join one 2¾" house and one 2¾" point half-square triangle to make a 2" point half-triangle square. Make 8. Join 2 HTSs to make 1 point pair. Make 4.

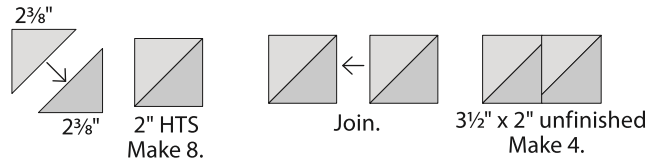

(B) Join one 3⅞" house and one 3⅞" pinwheel half-square triangle to make a 3½" pinwheel half-triangle square. Make 4.

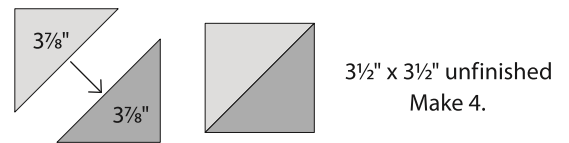

(C) Assemble a pointed pinwheel as shown.

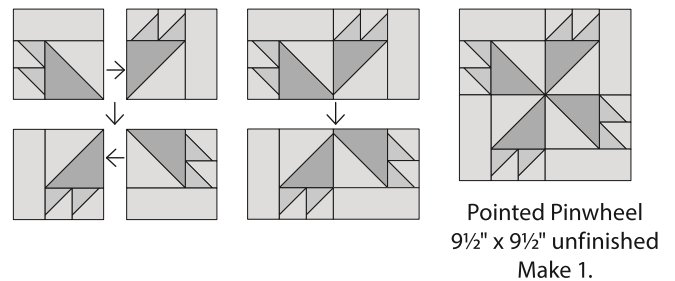
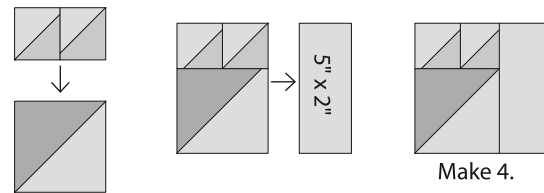

3 Assemble the house as shown.

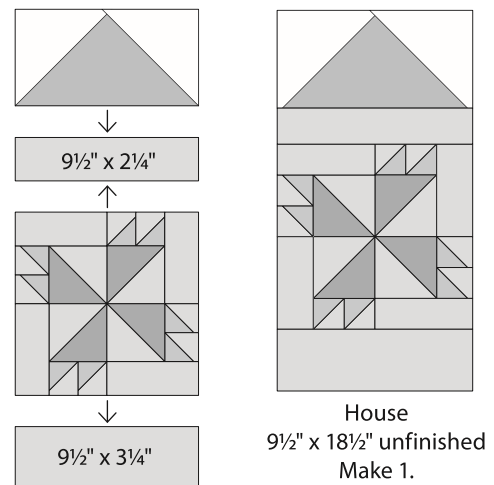

4 Assemble the tower.

(A) Join 2-1½" x 3½" backgrounds and 1-1½" x 3½" chimney to make the chimney.

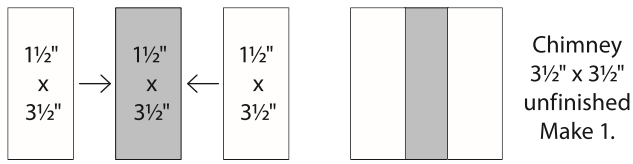

(B) Draw a diagonal line from corner to corner on the wrong side of the chimney square and a 3½" background square. Layer the marked background square, right sides to together, on 1-6½" x 3½" roof rectangle as shown. Sew on the diagonal line. Trim ¼" from the sewn line. Press to reveal the triangle. Repeat on the opposite end of the same rectangle using the marked chimney square. Make 1.

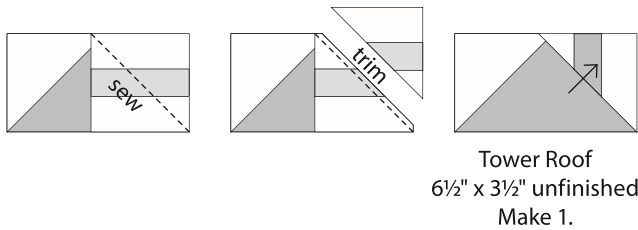
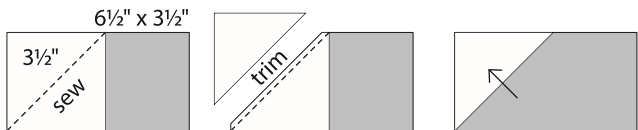

(C) Join 2-2" x 15½" backgrounds and 1-3½" x 15½" tower as shown.

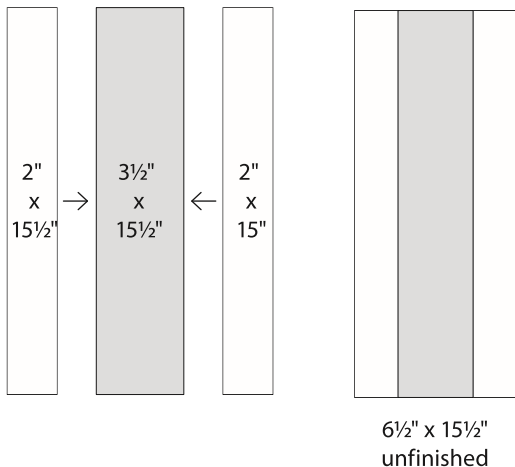

(C) Add the roof to finish the tower.

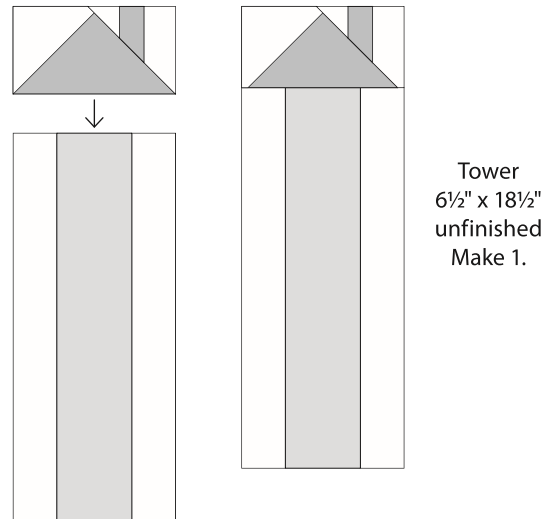

moda

5 Assemble the block as shown.

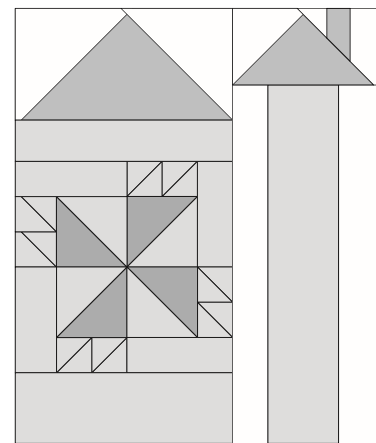
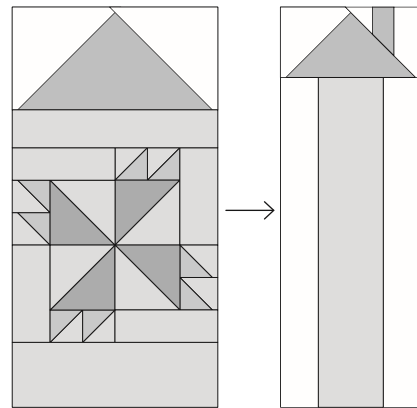

Block 2
15½" x 18½" unfinished



moda

Be My Neighbor

Block 3
15" x 18" finished

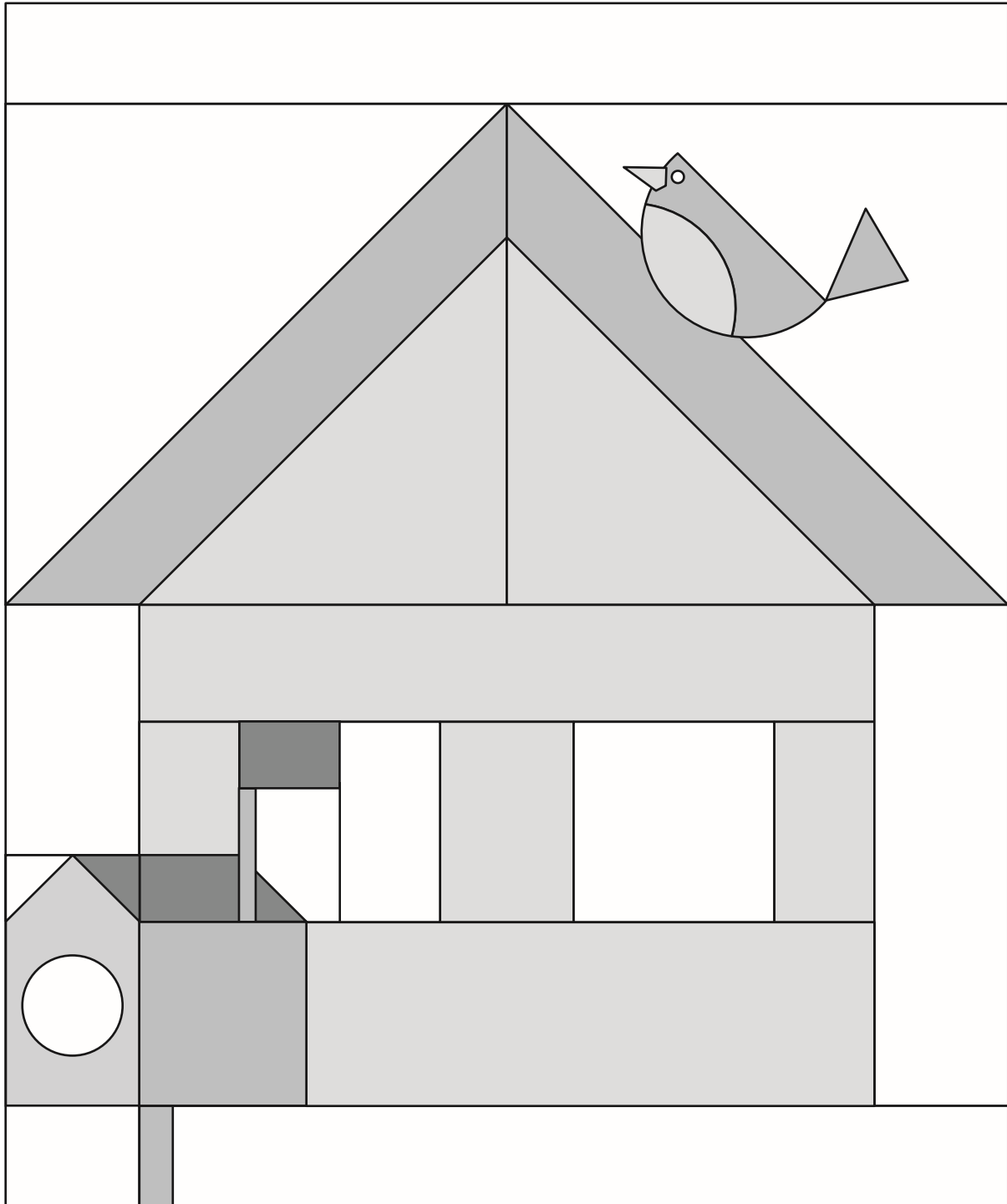

General Information

- These are very scrappy blocks. Mix your favorite Moda prints to create your colorful neighborhood!
- Share your progress and final quilt at #BeMyNeighbor. We love to see your results!!!

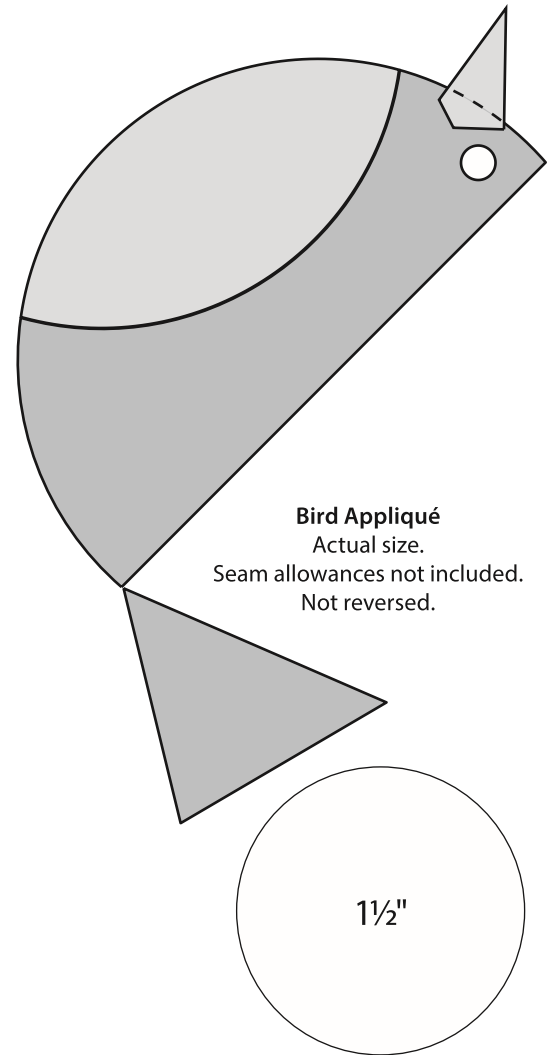
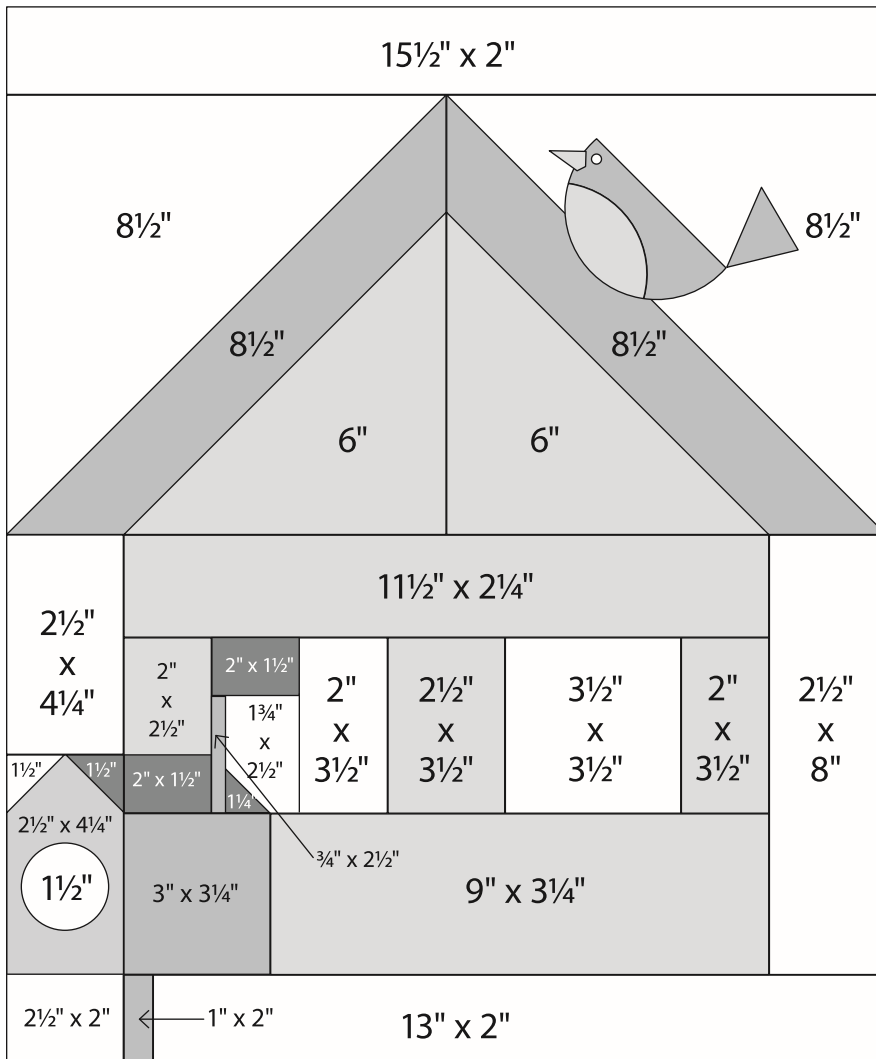

Block 3
15½" x 18½" unfinished

Cutting

House

- 1-11½" x 2¼" rectangle
- 1-9" x 3¼" rectangle
- 2-6" squares
- 1-2½" x 3½" rectangle
- 1-2" x 3½" rectangle
- 1-2" x 2½" rectangle

House Roof

- 1-8½" square
cut in half once on the diagonal to make 2 half-square triangles

Mailbox Front

- 1-2½" x 4¼" rectangle
- 1-1½ circle

Mailbox Side and Pole

- 1-3" x 3¼" rectangle
- 1-1" x 2" rectangle

Mailbox Roof

- 1-1¼" square
- 1-1½" square
- 1-2" x 1½" rectangle

Windows

- 1-3½" square
- 1-2" x 3½" rectangle
- 1-1¾" x 2½" rectangle

Flag

- 1-2½" x 1½" rectangle

Flag Pole

- 1-¾" x 2½" rectangle

Bird Appliqué

- 1-beak
- 1-body
- 1-tail
- 1-wing
- 1-eye

Background

- 1-15½" x 2" rectangle
- 1-13" x 2" rectangle
- 1-8½" square
cut in half once on the diagonal to make 2 half-square triangles
- 1-2½" x 8" rectangle
- 1-2½" x 4¼" rectangle
- 1-2½" x 2" rectangle
- 1-1½" square



Be My Neighbor

Block 3 is 15" x 18" finished.

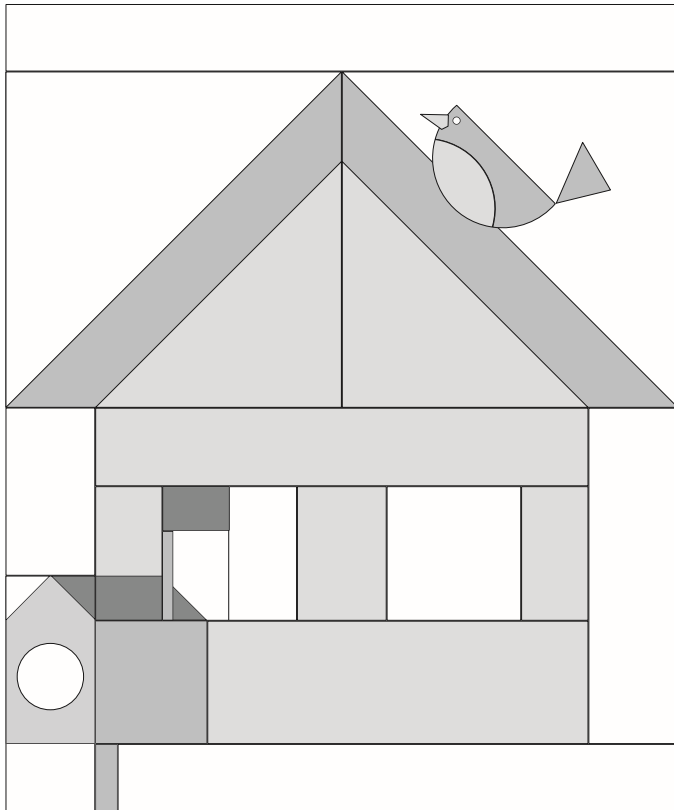

Construction

Use $\frac{1}{4}$ " seams. Press in the direction of the arrows in the diagrams.

1 House Roof

- (A) Join one $8\frac{1}{2}$ " roof and one $8\frac{1}{2}$ " background half-square triangle to make one half-triangle square (HTS). Make 2. Trim to 8".

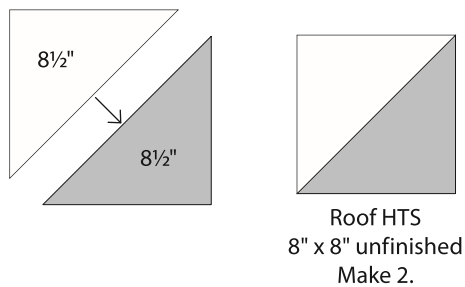

moda

house roof continued . . .

- (B) Draw a diagonal line from corner to corner on the wrong side of 2–6" house squares. Layer a marked house square, right sides to together, on a roof HTS as shown. Sew on the diagonal line. Trim the 6" house square only, $\frac{1}{4}$ " from the diagonal line. Press to reveal the triangle. Make 2. Join to make the house roof.

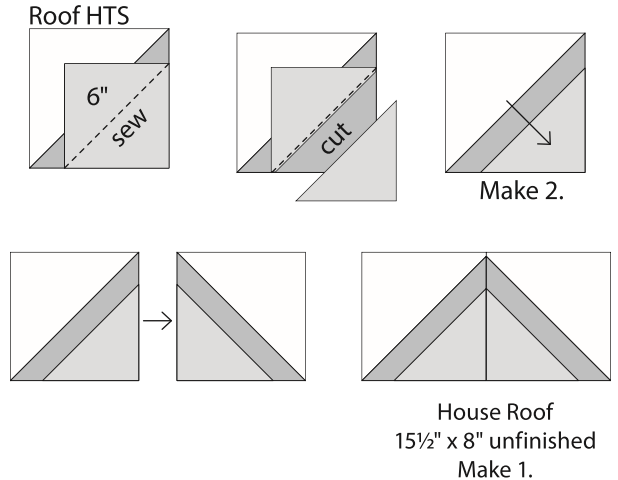

2 Mailbox

- Draw a diagonal line from corner to corner on the wrong side of 1– $\frac{1}{2}$ " background and 1– $\frac{1}{2}$ " mailbox roof squares. Layer a marked background square, right sides to together, on the $2\frac{1}{2}$ " x $4\frac{1}{4}$ " mailbox front as shown. Sew on the diagonal line. Trim $\frac{1}{4}$ " from the diagonal line. Press to reveal the triangle. Repeat using the marked $1\frac{1}{2}$ " mailbox square on the opposite corner as shown. Appliqué the circle to the front. Add a $2\frac{1}{2}$ " x $4\frac{1}{4}$ " background rectangle as shown.

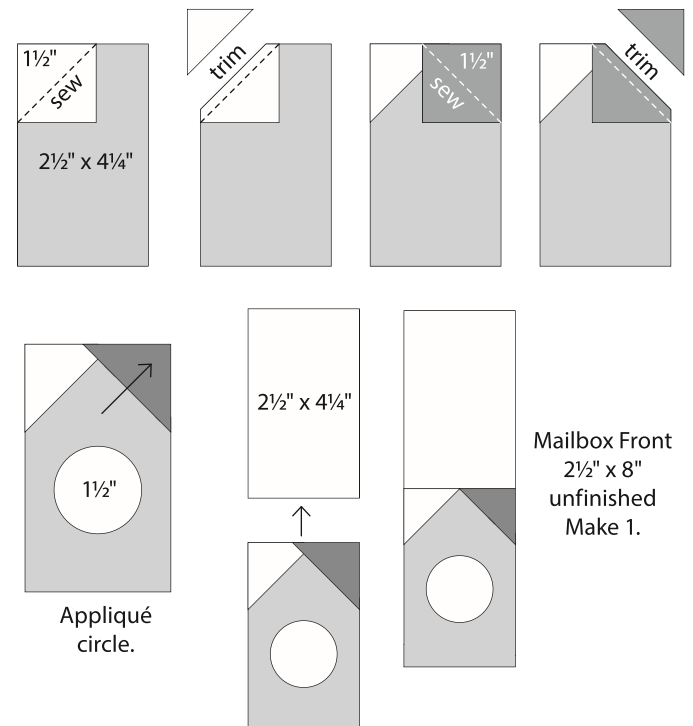

3 Mailbox Flag and House Windows

Draw a diagonal line from corner to corner on the wrong side of 1-1/4" mailbox roof square. Layer the marked square, right sides to together, on the 1 3/4" x 2 1/2" window as shown. Sew on the diagonal line. Trim 1/4" from the diagonal line. Press to reveal the triangle.

Follow the steps to assemble the mailbox flag and house windows.

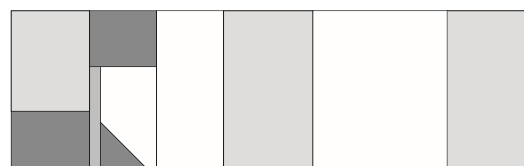
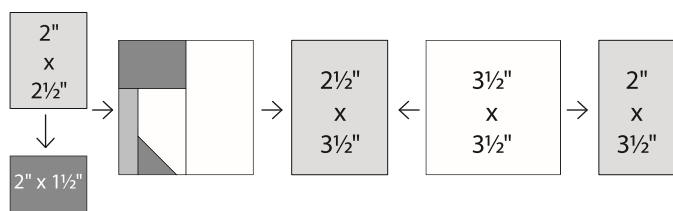
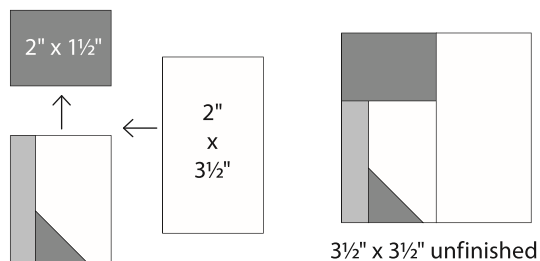
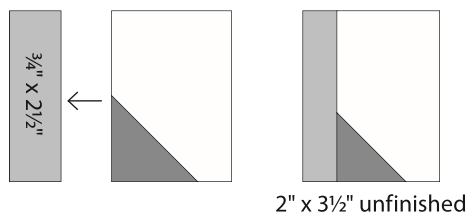
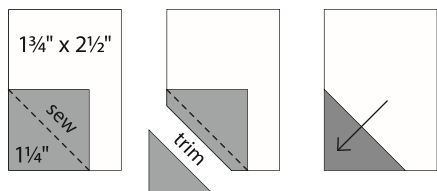

Mailbox Flag and House Windows
1 1/2" x 3 1/2" unfinished

4 Assemble the block.

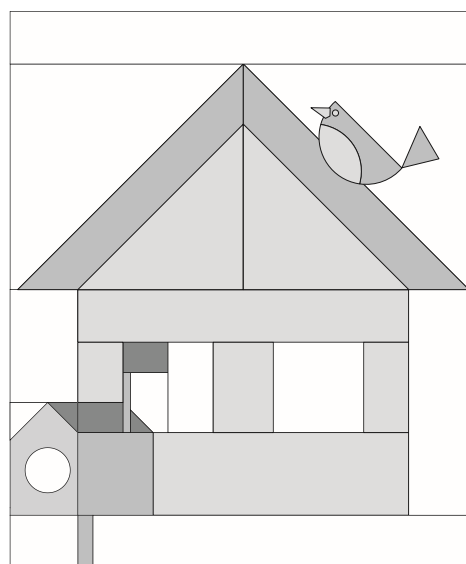
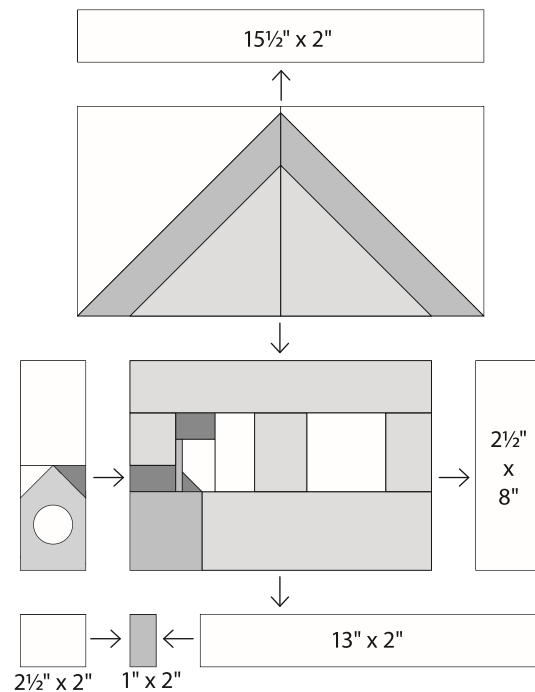
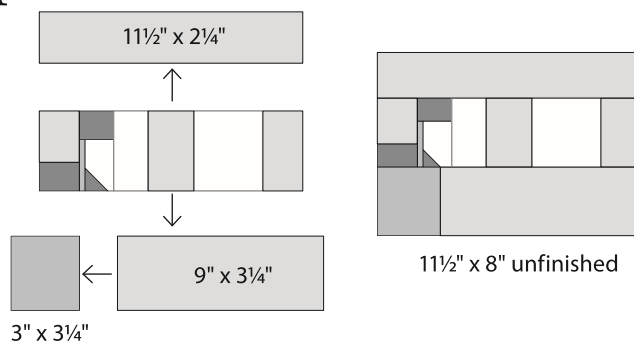

Block 3
15 1/2" x 18" unfinished

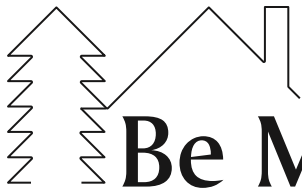

moda

Be My Neighbor

Block 4

12" x 18" finished

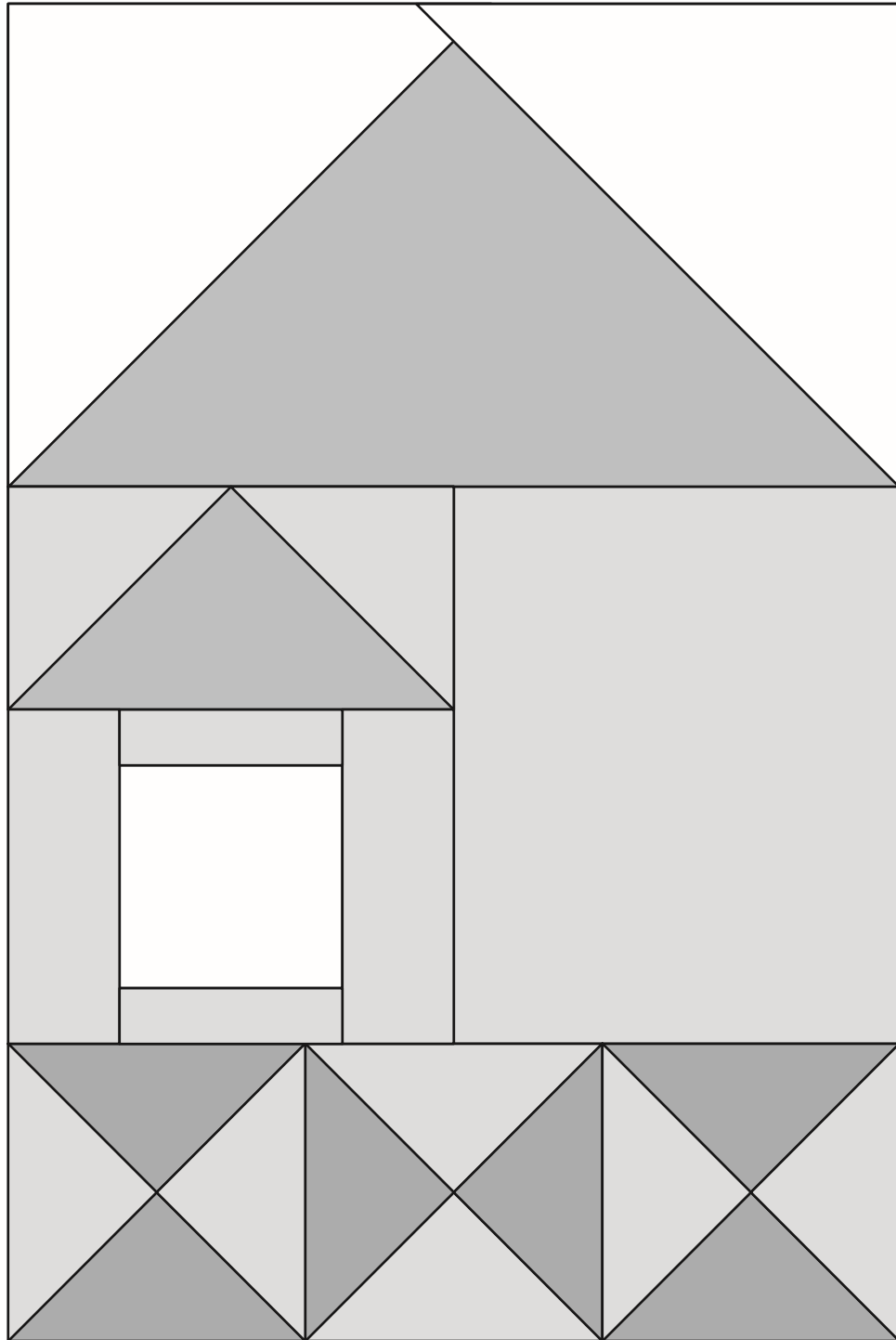

General Information

- These are very scrappy blocks. Mix your favorite Moda prints to create your colorful neighborhood!
- Share your progress and final quilt at #BeMyNeighbor. We love to see your results!!!

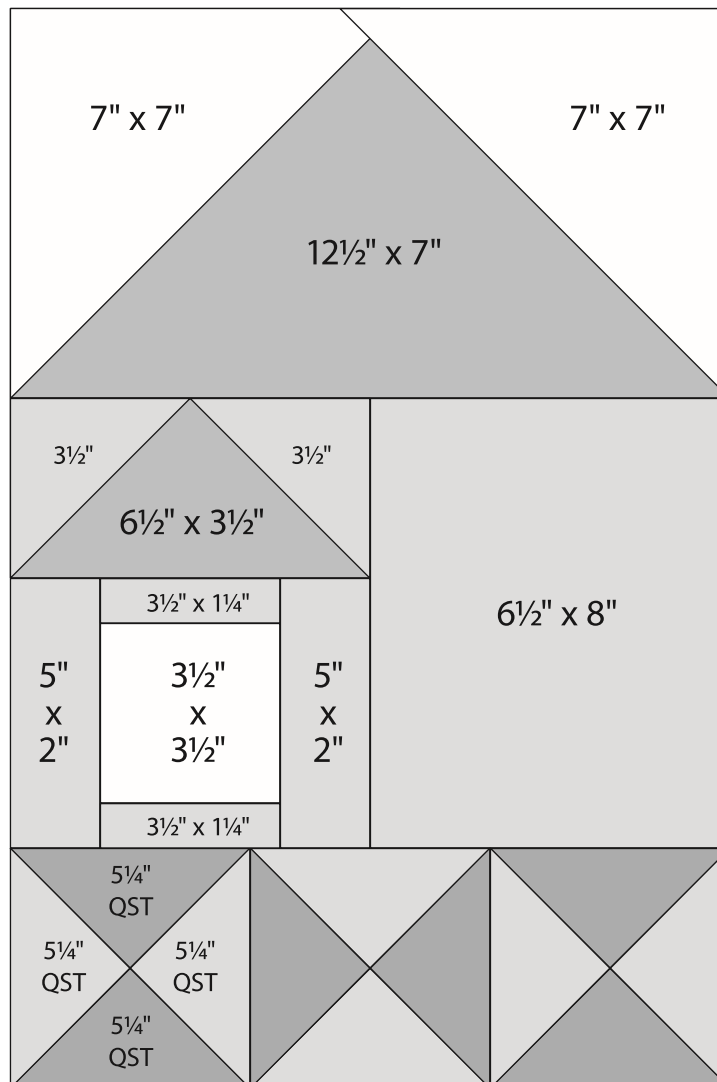

Block 4
12½" x 18½" unfinished

Cutting

House Roof Large

1–12½" x 7" rectangle

House Roof Small

1–6½" x 3½" rectangle

Quarter-Square Triangles

2–5¼" squares

cut in half twice on the diagonal to
make 8 quarter-square triangles (need 6)

House

1–6½" x 8" rectangle

2–5¼" squares

cut in half twice on the diagonal to
make 8 quarter-square triangles (need 6)

2–5" x 2" rectangles

2–3½" squares

2–3½" x 1¼" rectangles

Window

1–3½" square

Background

2–7" squares



Be My Neighbor

Block 4 is 12" x 18" finished.

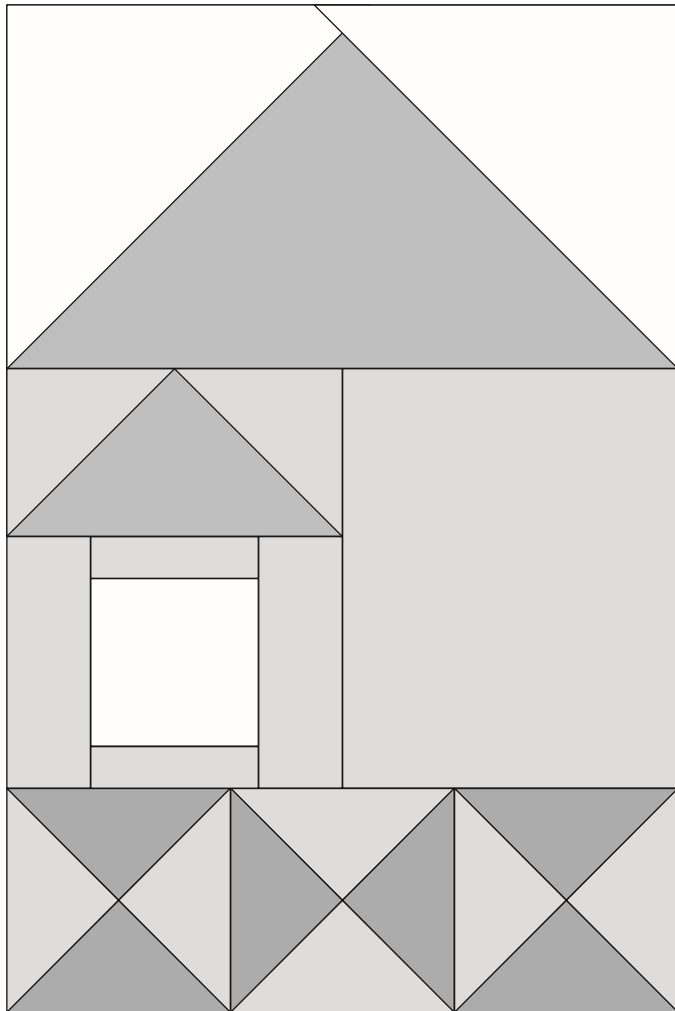

moda

Construction

Use $\frac{1}{4}$ " seams. Press in the direction of the arrows in the diagrams.

1 House Roof Large

Draw a diagonal line from corner to corner on the wrong side of 2-7" background squares. Layer a 7" marked background square, right sides to together, on 1-12½" x 7" large roof rectangle as shown. Sew on the diagonal line. Trim $\frac{1}{4}$ " from the sewn line. Press to reveal the triangle. Repeat on the the opposite end of the same rectangle. Make 1.

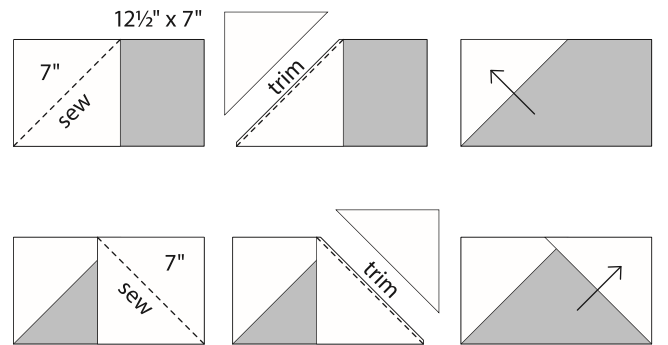

House Roof Large
12½" x 7" unfinished
Make 1.

2 House Roof Small

Draw a diagonal line from corner to corner on the wrong side of 2-3½" house squares. Layer a 3½" marked house square, right sides to together, on 1-6½" x 3½" small roof rectangle as shown. Sew on the diagonal line. Trim $\frac{1}{4}$ " from the sewn line. Press to reveal the triangle. Repeat on the the opposite end of the same rectangle. Make 1.

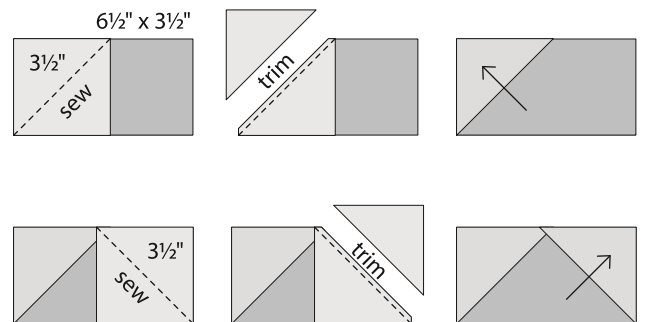

House Roof Small
6½" x 3½" unfinished
Make 1.

3 Assemble the window section as shown.

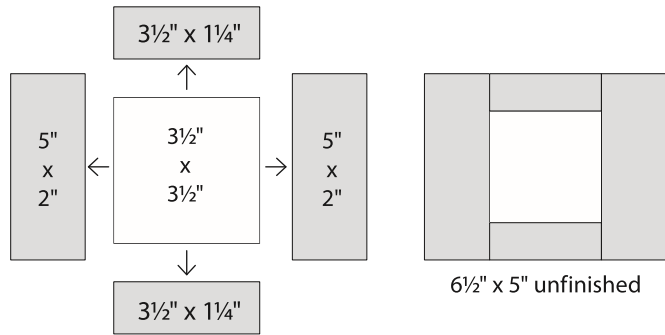

House Roof Small

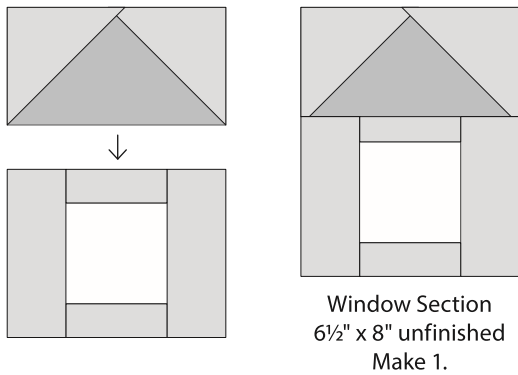

4 House Base

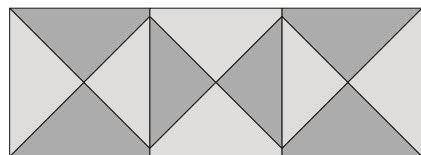
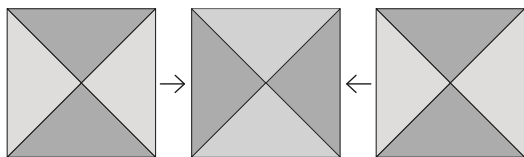
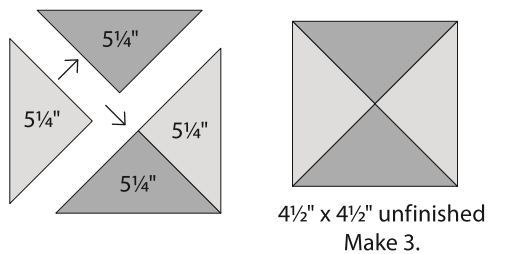

5 Assemble the block as shown.

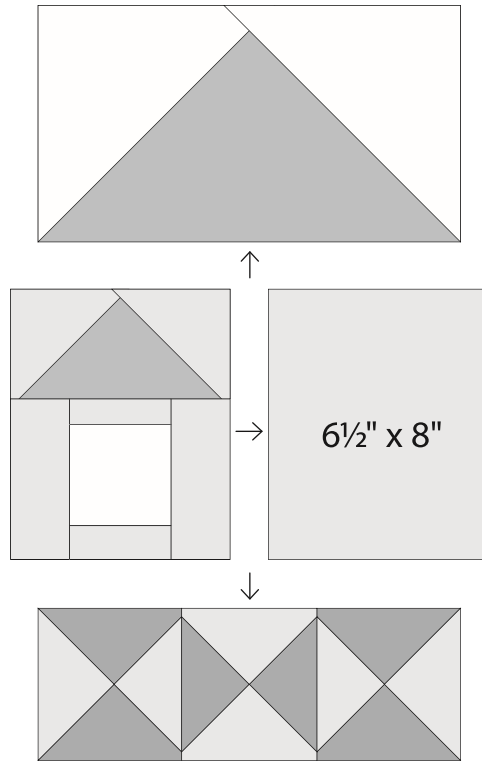

moda

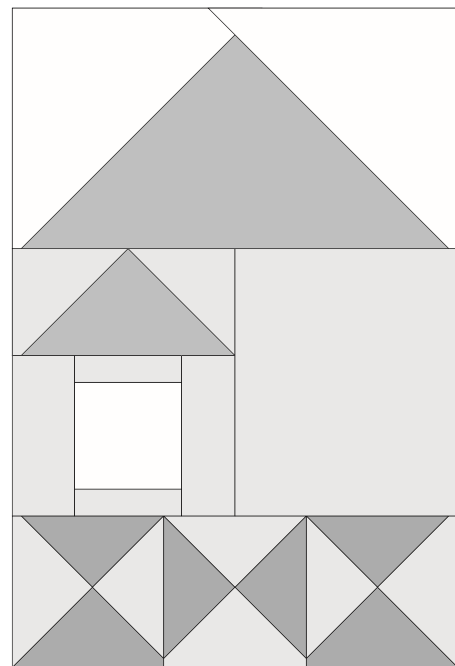

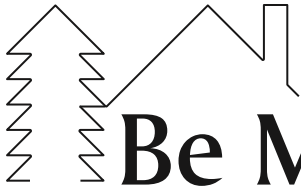

moda

Be My Neighbor

Block 5

12" x 18" finished

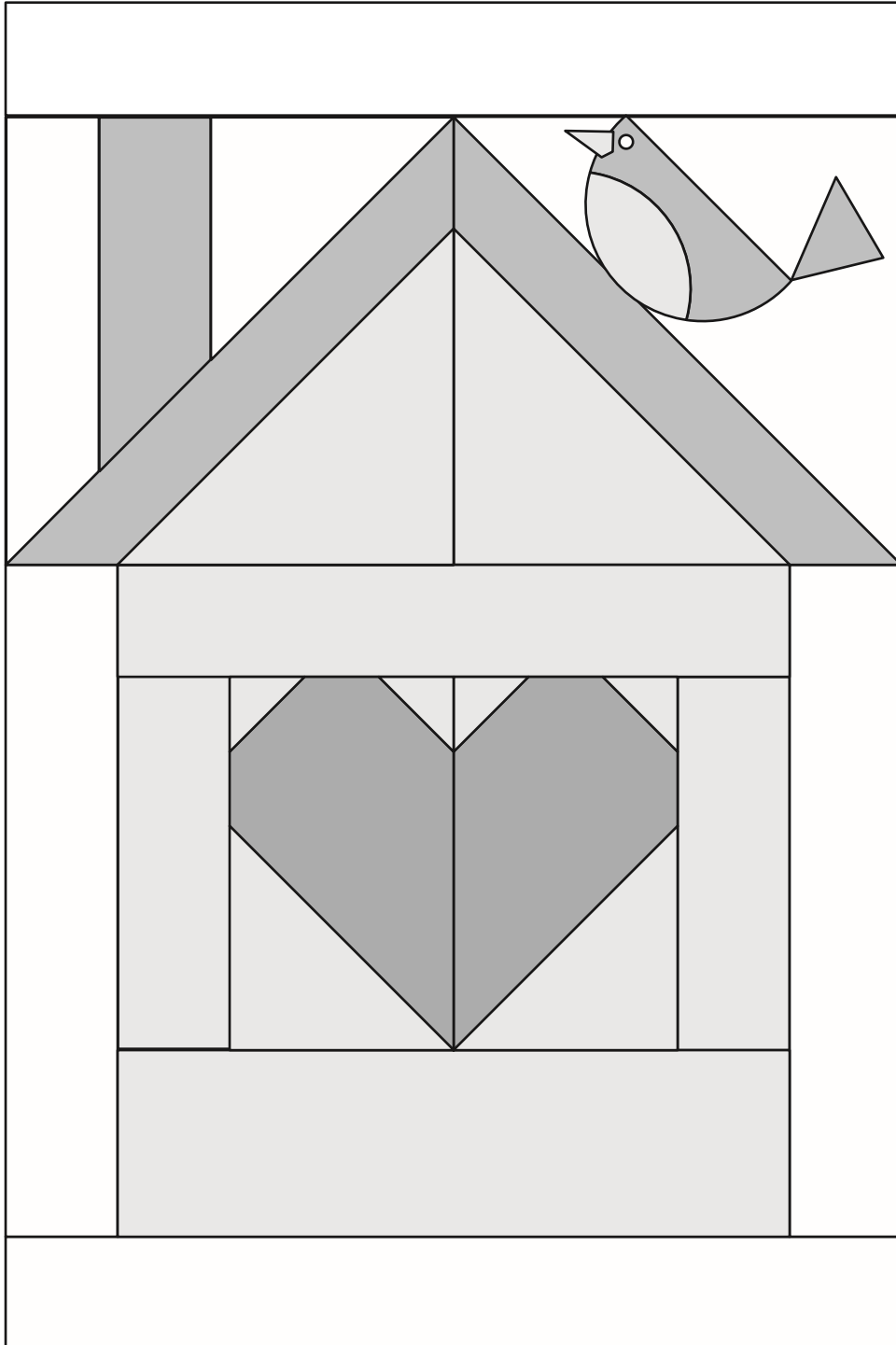

General Information

- These are very scrappy blocks. Mix your favorite Moda prints to create your colorful neighborhood!
- Share your progress and final quilt at #BeMyNeighbor. We love to see your results!!!

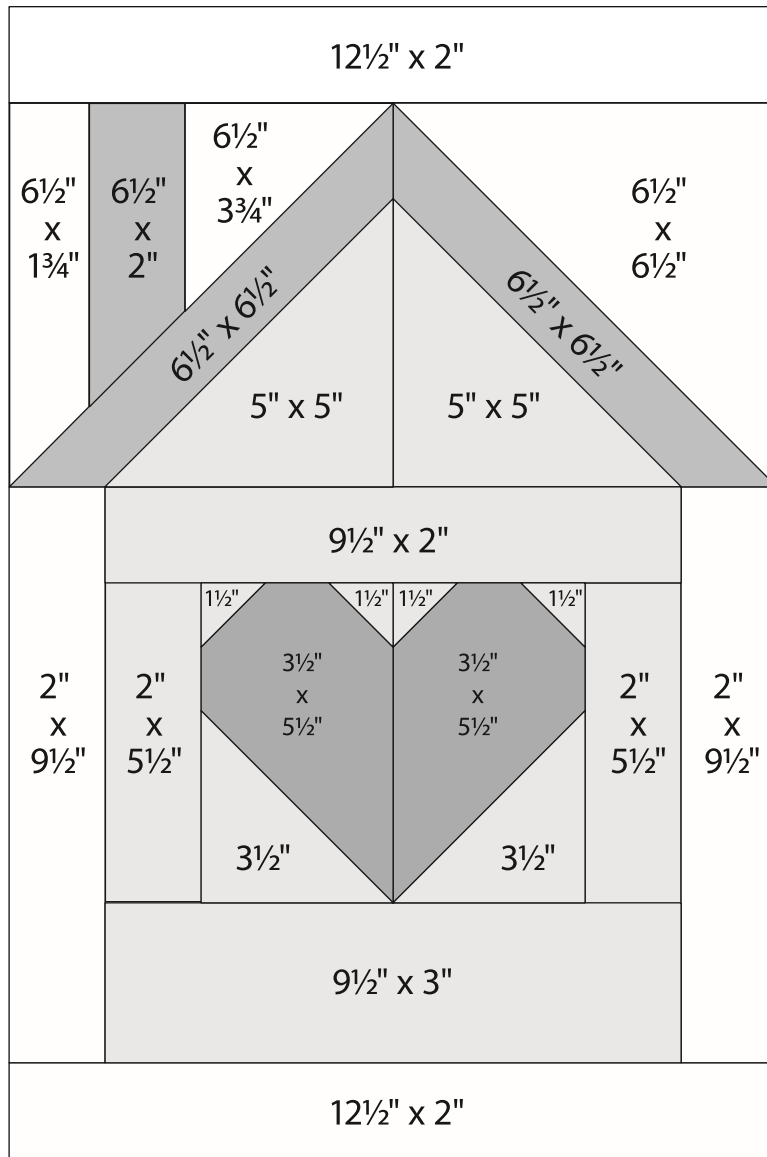

Block 5
12½" x 18½" unfinished

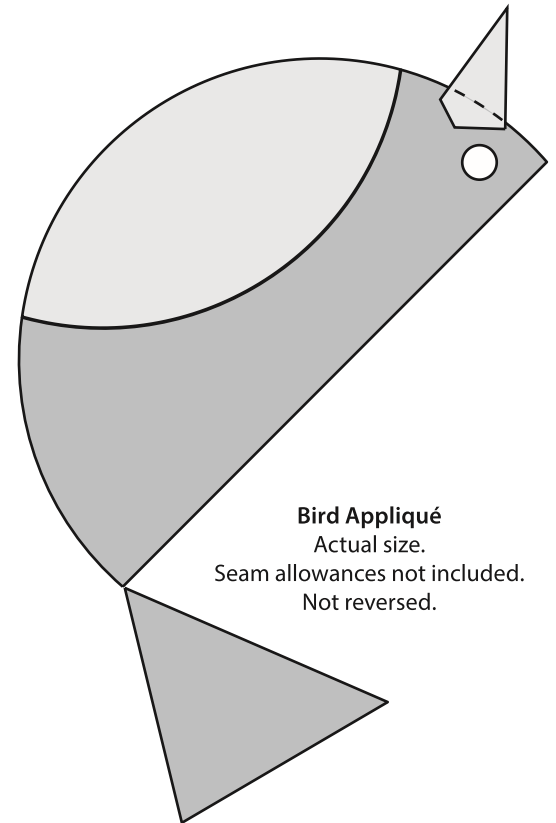

Cutting

House

- 1–9½" x 3" rectangles
- 1–9½" x 2" rectangles
- 2–5½" x 2" rectangles
- 2–5" squares
- 2–3½" squares
- 4–1½" squares

Roof: 2–6½" squares

Chimney: 1–2" x 6½"

Heart: 2–3½" x 5½"

Background

- 1–6½" square
- 1–6½" x 3¾" rectangle
- 1–6½" x 1¾" rectangle
- 2–2" x 12½" rectangles
- 2–2" x 9½" rectangles

Bird Appliqué

- 1–beak
- 1–body
- 1–tail
- 1–wing
- 1–eye



moda Be My Neighbor

Block 5 is 12" x 18" finished.

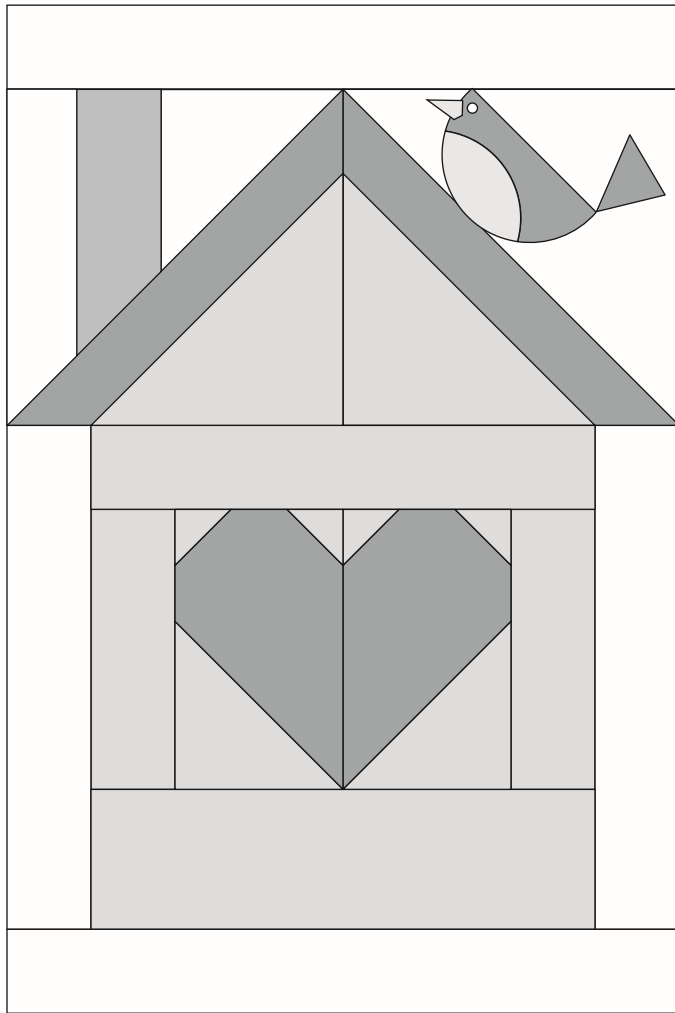

Construction

Use $\frac{1}{4}$ " seams. Press in the direction of the arrows in the diagrams.

1 Roof

- (A) Join a $1\frac{3}{4}$ " x $6\frac{1}{2}$ " background, 2" x $6\frac{1}{2}$ " chimney, and $3\frac{3}{4}$ " x $6\frac{1}{2}$ " background strip as shown.

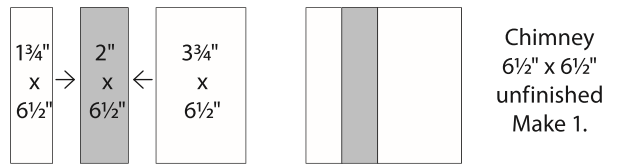

- (B) Draw a diagonal line from corner to corner on the wrong side of 2–5" house squares. Layer a 5" marked background square, right sides to together, on 1– $6\frac{1}{2}$ " roof square as shown. Sew on the diagonal line. Trim $\frac{1}{4}$ " from the sewn line. Press to reveal the triangle. Make 2.

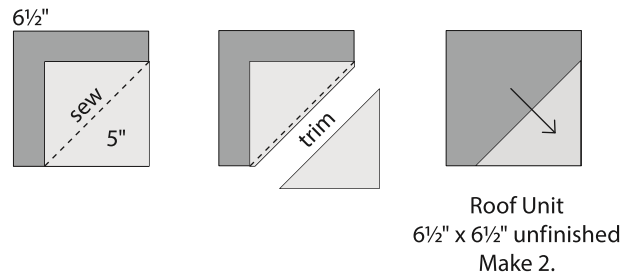

- (C) Draw a diagonal line from corner to corner on the wrong side of the chimney as shown. Layer the marked chimney, right sides together, on a roof unit as shown. Sew, trim, and press. Make 1.

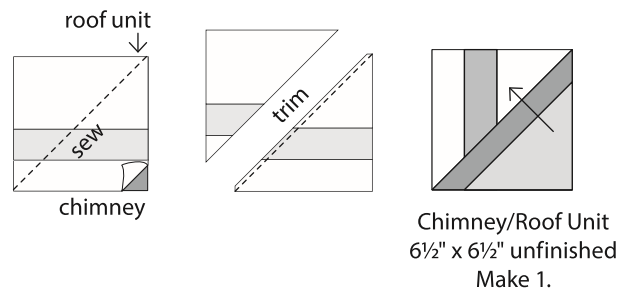

moda

(D) Draw a diagonal line from corner to corner on the wrong side of a 6½" background square. Layer the marked square, right sides together, on a roof unit as shown. Sew, trim, and press to reveal the triangle. Make 1. Join units to make the roof.

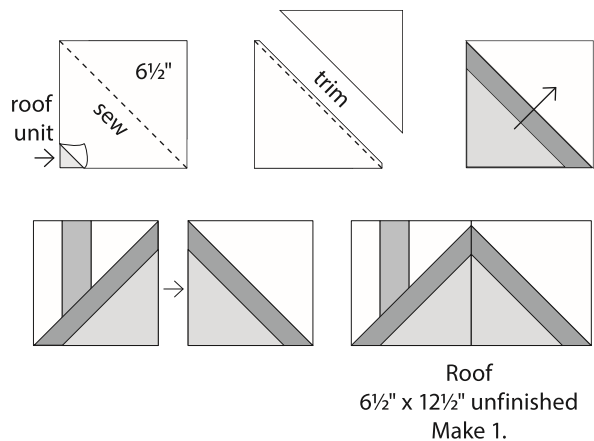

2 Heart Draw a diagonal line from corner to corner on the wrong side of 2–3½" house squares, and 4–1½" house squares. Layer, sew, trim, and press as shown on 2–3½" x 5½" hearts. Join the 2 sides to make the heart.

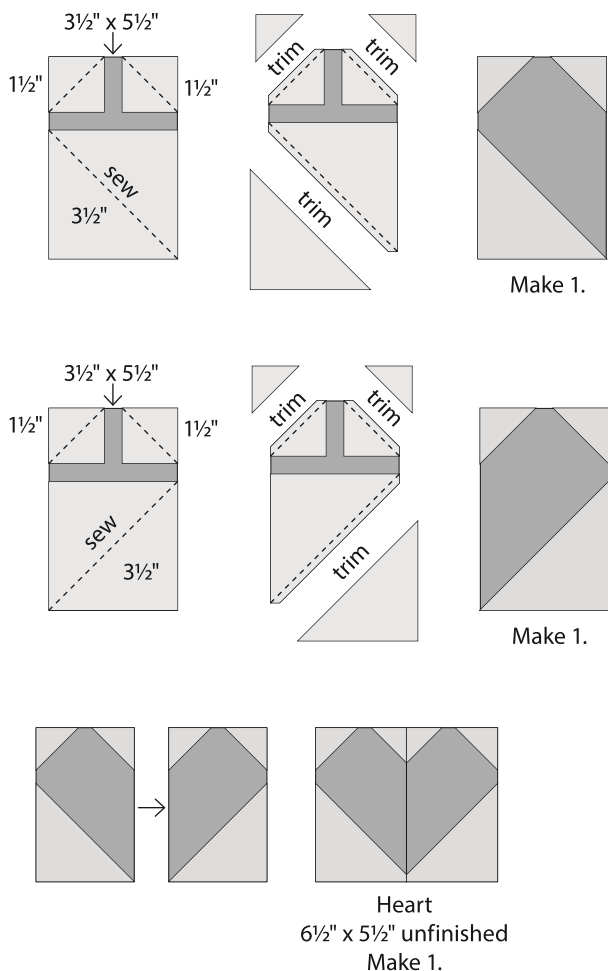

3 House assembly Assemble the heart house as shown. Use fusible web and a zig zag or blanket stitch to add the bird to the completed house block.

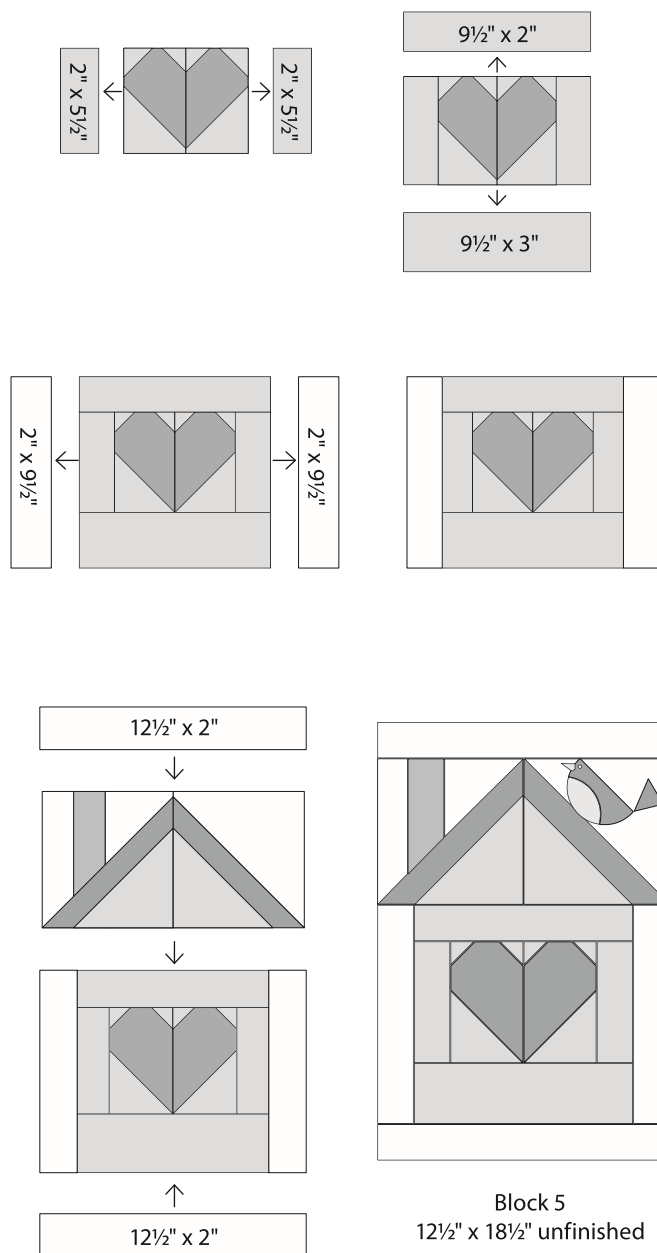

moda

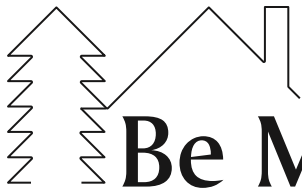

moda

Be My Neighbor

Block 6

18" x 18" finished

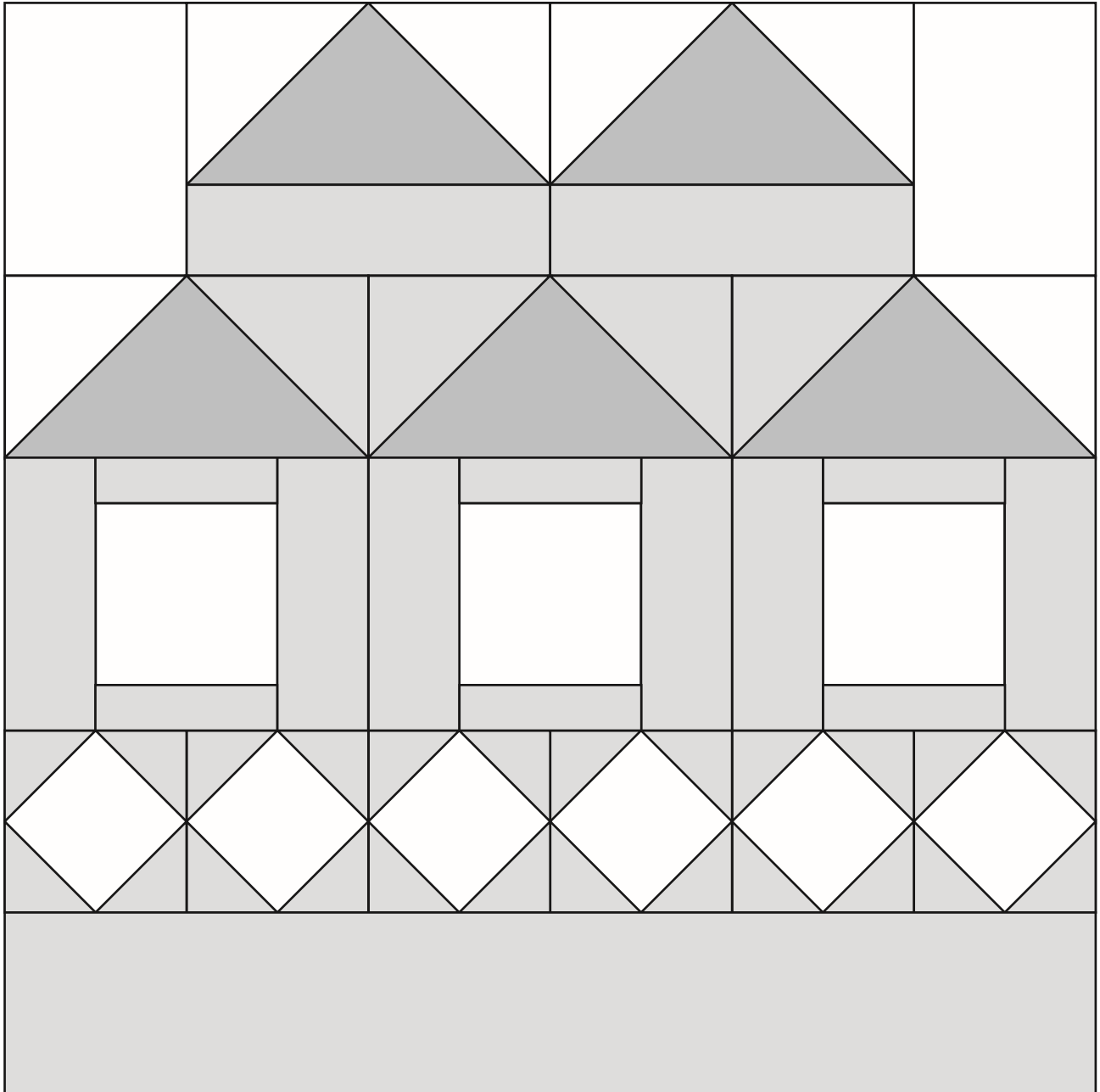

General Information

- These are very scrappy blocks. Mix your favorite Moda prints to create your colorful neighborhood!
- Share your progress and final quilt at #BeMyNeighbor. We love to see your results!!!

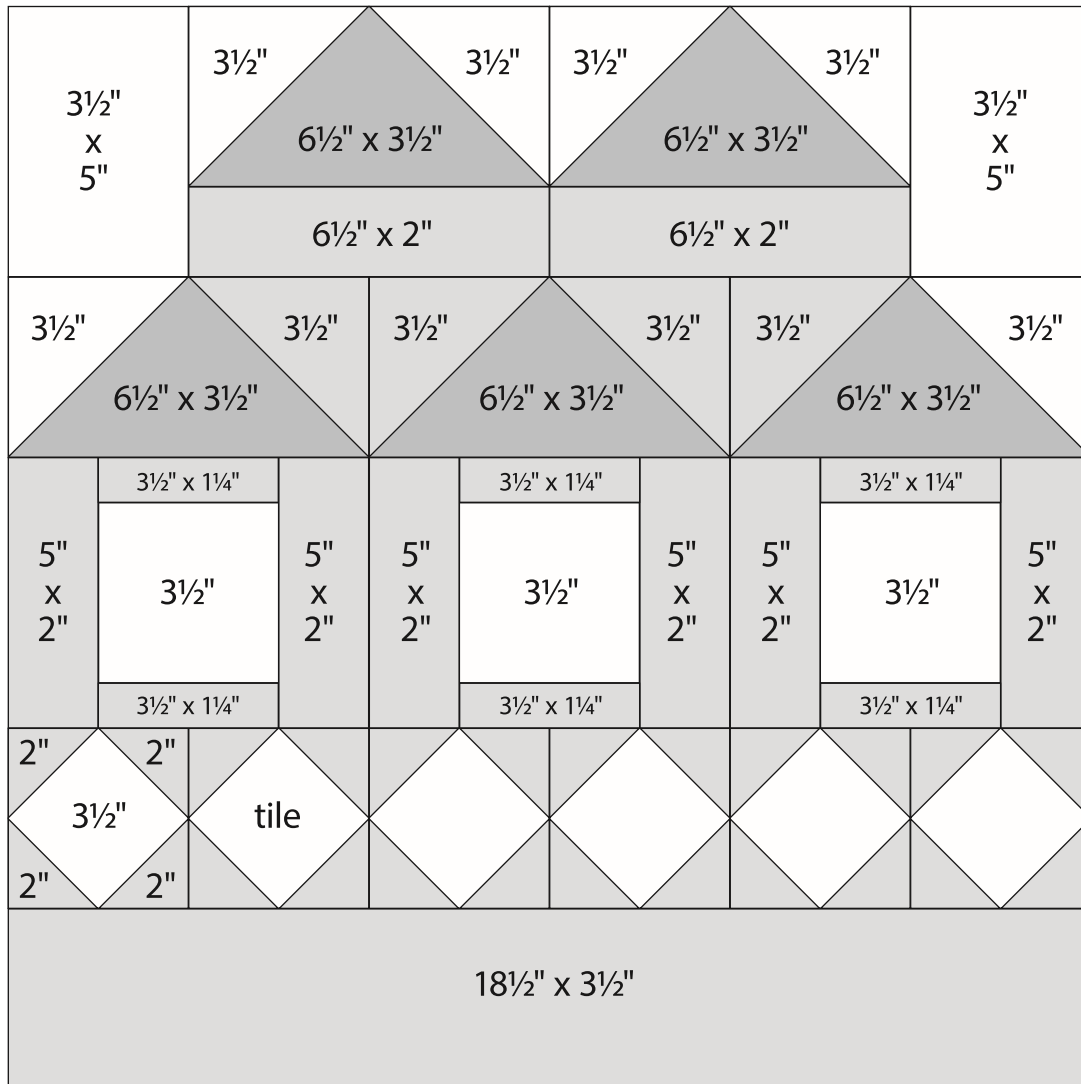

Block 6
18½" x 18½" unfinished

Cutting

House Rooftops

5–6½" x 3½" rectangles

Tiles

6–3½" squares

Windows

3–3½" squares

House

1–18½" x 3½" rectangle

2–6½" x 2" rectangles

6–5" x 2" rectangles

4–3½" squares

6–3½" x 1¼" rectangles

24–2" squares

Background

2–3½" x 5" rectangles

6–3½" squares

Be My Neighbor

Block 6 is 18" x 18" finished.

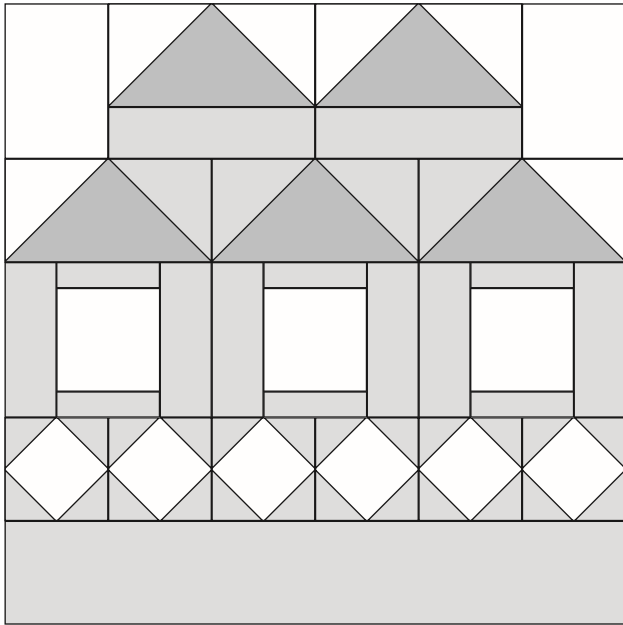

Construction

Use $\frac{1}{4}$ " seams. Press in the direction of the arrows in the diagrams.

1 House Rooftops A, B, C, and D

Draw a diagonal line from corner to corner on the wrong side of $4-3\frac{1}{2}$ " house squares and $6-3\frac{1}{2}$ " background squares.

The same technique is used to make all the roof tops. Just note whether you are using a marked house or marked background square. Layer a marked square, right sides to together, on $1-6\frac{1}{2}$ " x $3\frac{1}{2}$ " roof rectangle as shown. Sew on the diagonal line. Trim $\frac{1}{4}$ " from the sewn line. Press to reveal the triangle. Repeat on the opposite end of the same rectangle.

House Roof A

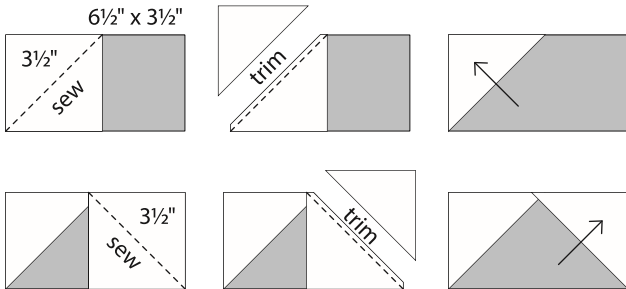

House Roof A
 $6\frac{1}{2}$ " x $3\frac{1}{2}$ " unfinished
Make 2.

house roof tops continued . . .

House Roof B

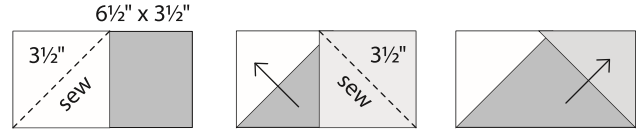

House Roof B
 $6\frac{1}{2}$ " x $3\frac{1}{2}$ " unfinished
Make 1.

House Roof C

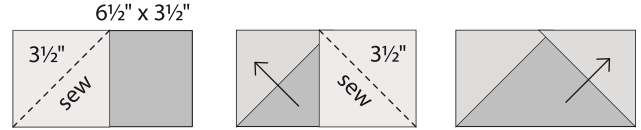

House Roof C
 $6\frac{1}{2}$ " x $3\frac{1}{2}$ " unfinished
Make 1.

House Roof D

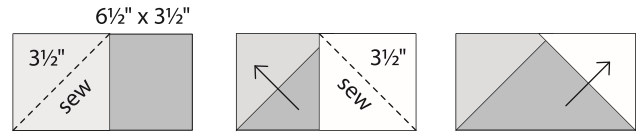

House Roof D
 $6\frac{1}{2}$ " x $3\frac{1}{2}$ " unfinished
Make 1.

2 Assemble windows and rooftops as shown.

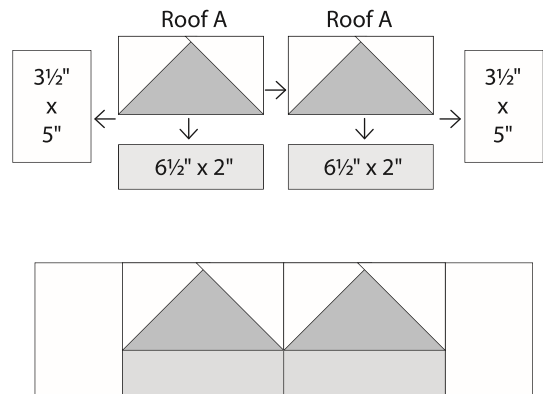
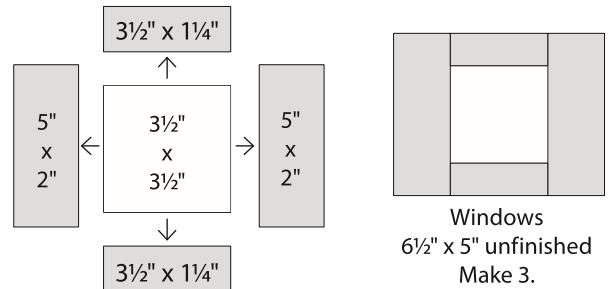

$18\frac{1}{2}$ " x 5" unfinished

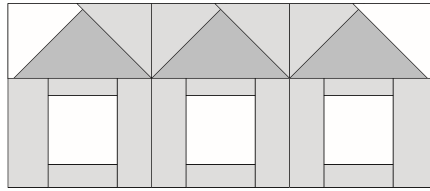
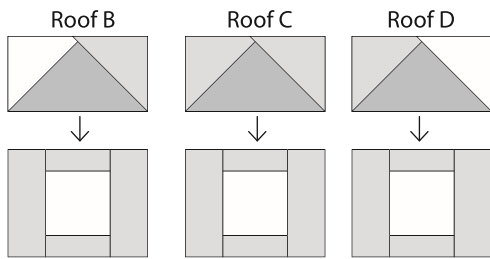

18½" x 8" unfinished

3 House Tiles

Draw a diagonal line from corner to corner on the wrong side of 24–2" house squares. Layer 2 marked squares on opposite corners of a 3" tile square, right sides to together. Sew on the diagonal lines. Trim ¼" from the sewn line. Press to reveal the triangles. Repeat on the opposite ends of the same square. Make 6.

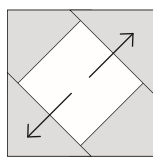
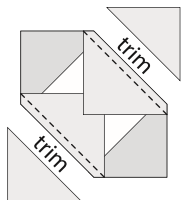
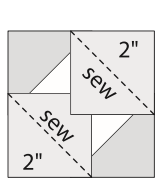
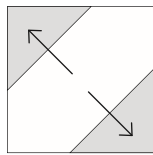
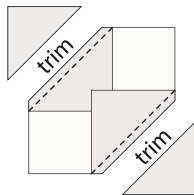
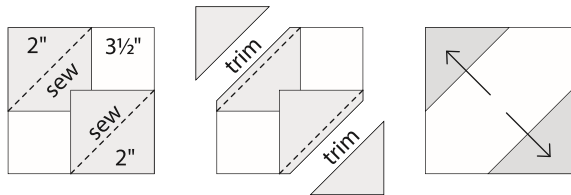

3½" x 3½" unfinished
Make 6.

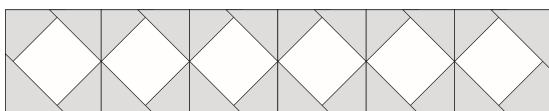
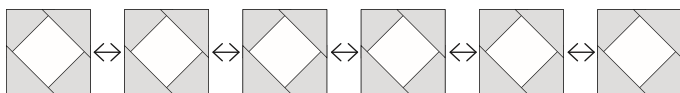

Tiles
18½" x 3½" unfinished
Make 1.

4 Assemble the block as shown.

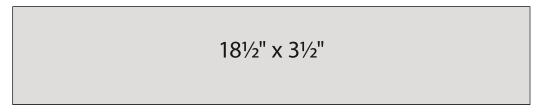
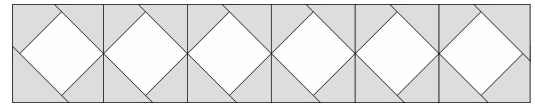
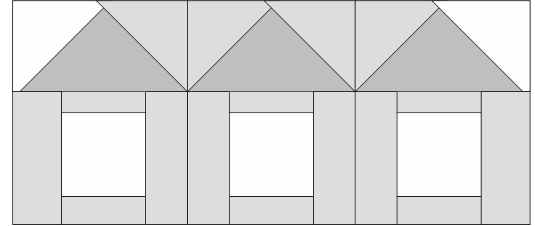
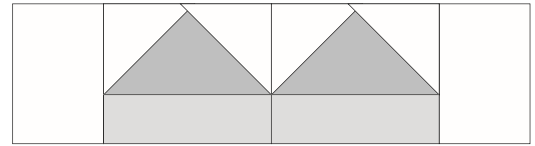

18½" x 3½"

moda

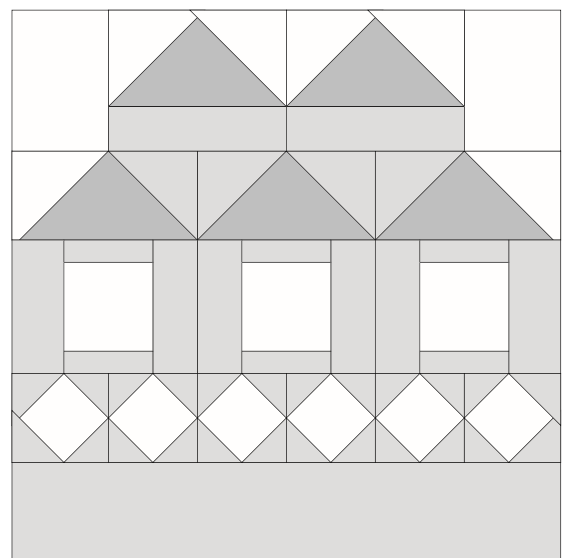

Block 6
18½" x 18½" unfinished

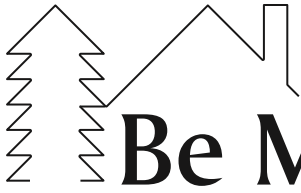

moda

Be My Neighbor

Block 7
15" x 18" finished

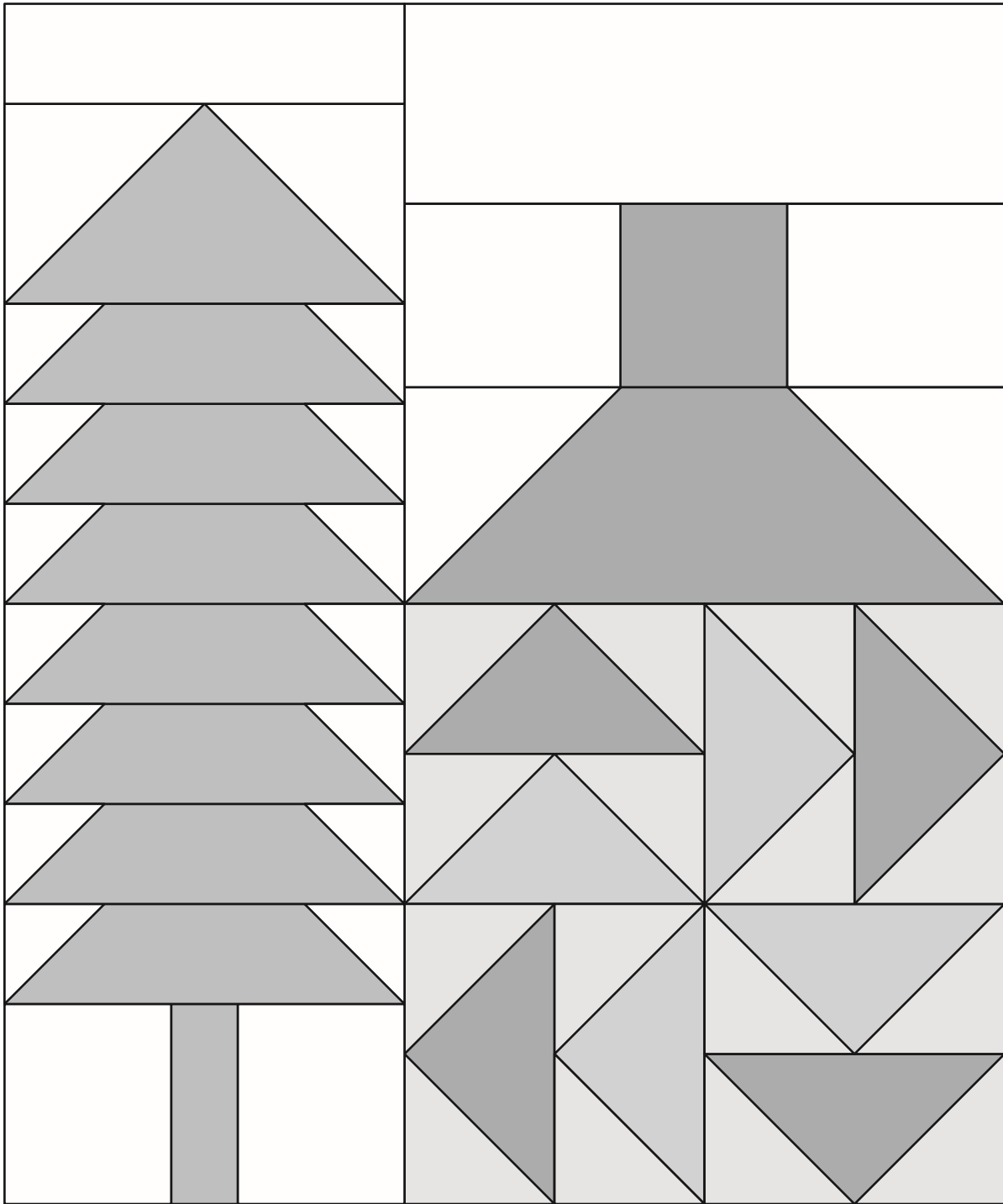

General Information

- These are very scrappy blocks. Mix your favorite Moda prints to create your colorful neighborhood!
- Share your progress and final quilt at #BeMyNeighbor. We love to see your results!!!

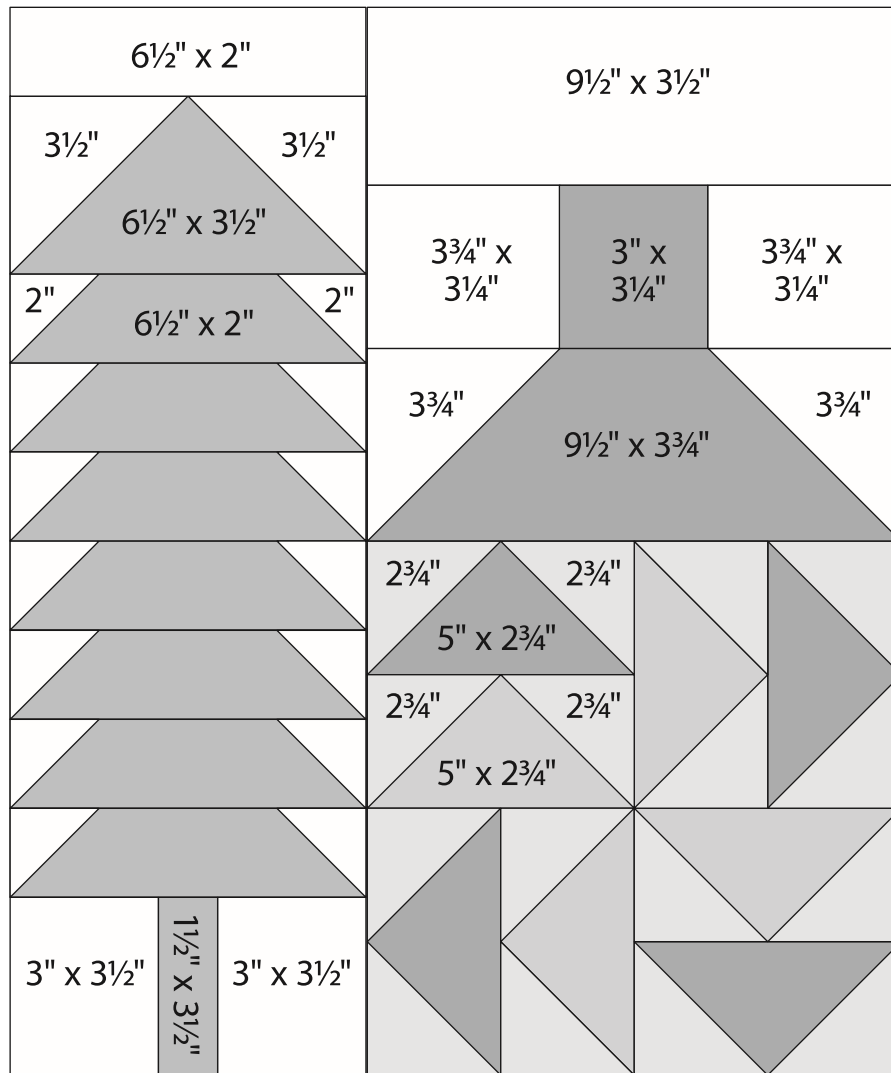

Block 7
15 1/2" x 18 1/2" unfinished

Cutting

Tree

- 1-6 1/2" x 3 1/2" rectangle
- 7-6 1/2" x 2" rectangles

Tree Trunk

- 1-1 1/2" x 3 1/2" rectangle

House Roof and Chimney

- 1-9 1/2" x 3 3/4" rectangle
- 1-3" x 3 1/4" rectangle

House

- 16-2 3/4" squares

Flying Geese Dark

- 4-5" x 2 3/4" rectangles

Flying Geese Medium

- 4-5" x 2 3/4" rectangles

Background

- 1-9 1/2" x 3 1/2" rectangle
- 1-6 1/2" x 2" rectangle
- 2-3 3/4" squares
- 2-3 3/4" x 3 1/4" rectangles
- 2-3 1/2" squares
- 2-3" x 3 1/2" rectangles
- 14-2" squares



moda Be My Neighbor

Block 7 is 15" x 18" finished.

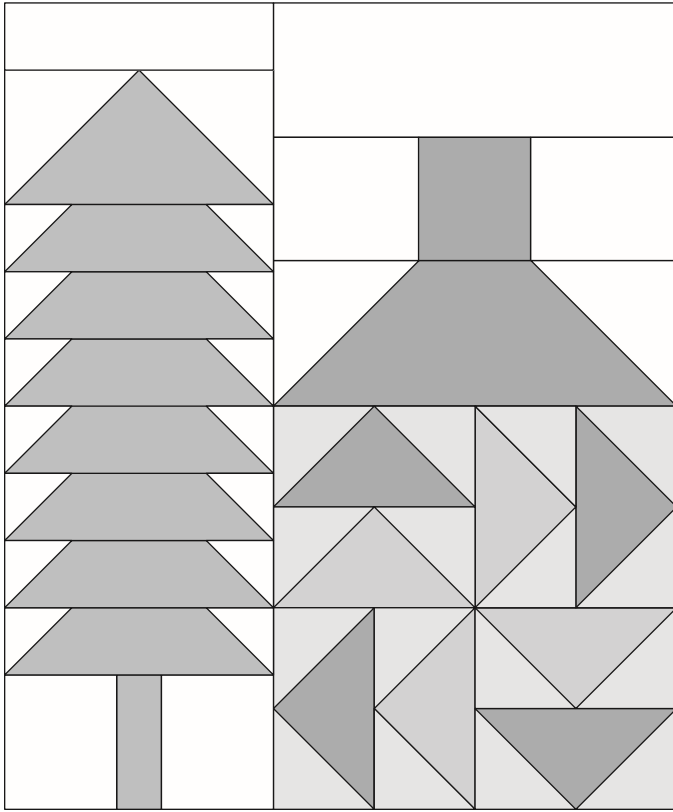

Construction

Use $\frac{1}{4}$ " seams. Press in the direction of the arrows in the diagrams.

1 House

- (A) Draw a diagonal line from corner to corner on the wrong side of $2-3\frac{3}{4}$ " background squares. Layer a $3\frac{3}{4}$ " marked background square, right sides to together, on both ends of a $1-9\frac{1}{2}$ " x $3\frac{3}{4}$ " roof rectangle as shown. Sew on the diagonal lines. Trim $\frac{1}{4}$ " from the sewn lines. Press to reveal the triangles.

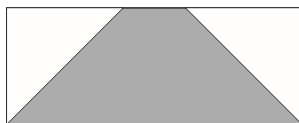
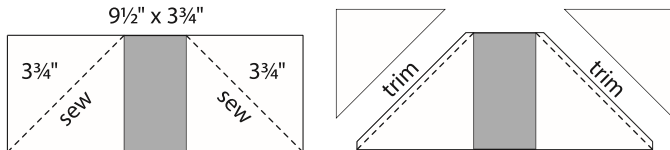

Roof
 $9\frac{1}{2}$ " x $3\frac{3}{4}$ " unfinished

House continued . . .

- (B) Draw a diagonal line from corner to corner on the wrong side of $16-2\frac{3}{4}$ " house squares. Layer a $2\frac{3}{4}$ " marked house square, right sides to together, on $1-5$ " x $2\frac{3}{4}$ " flying geese rectangle as shown. Sew on the diagonal line. Trim $\frac{1}{4}$ " from the sewn line. Press to reveal the triangle. Repeat on the opposite end of the same rectangle. Make 4 dark and 4 medium.

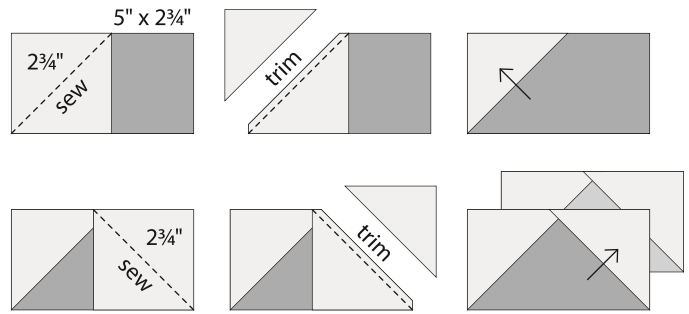

Flying Geese
 5 " x $2\frac{3}{4}$ " unfinished
Make 4 dark and 4 medium.

- (C) Join 1 dark and medium flying geese as shown. Make 4.

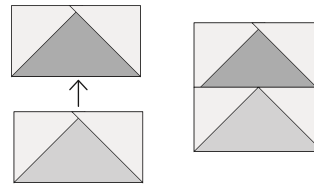

5 " x 5 " unfinished
Make 4.

- (D) Assemble the house bottom.

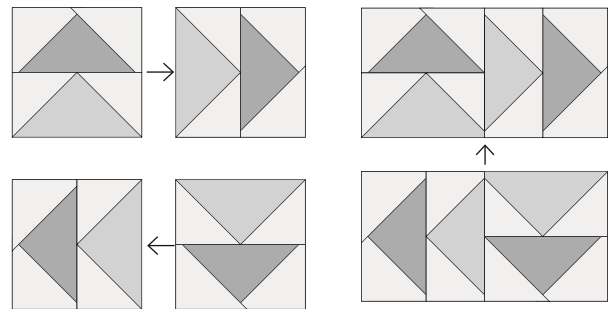

House Bottom
 $9\frac{1}{2}$ " x $9\frac{1}{2}$ " unfinished

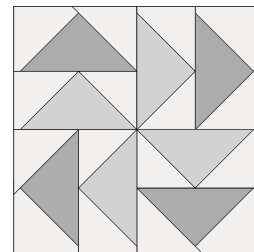

moda

House continued . . .

(E) Assemble the house as shown.

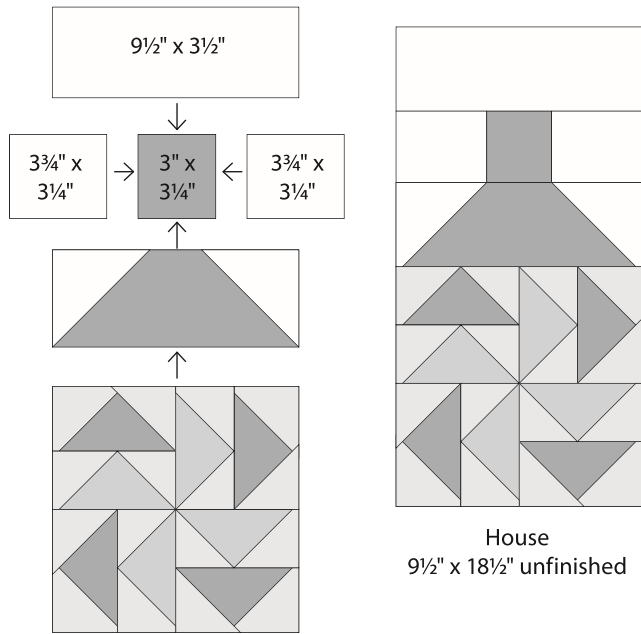

(C) Assemble the tree as shown.

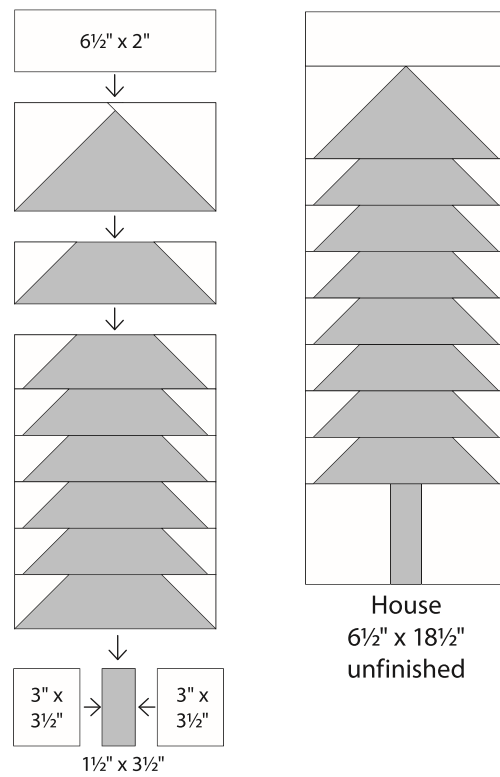

2 Tree

(A) Draw a diagonal line from corner to corner on the wrong side of 2–3 1/2" background squares. Layer a 3 1/2" marked background square, right sides to together, on 1–6 1/2" x 3 1/2" tree rectangle as shown. Sew on the diagonal line. Trim 1/4" from the sewn line. Press to reveal the triangle. Repeat on the opposite end of the same rectangle. Make 1.

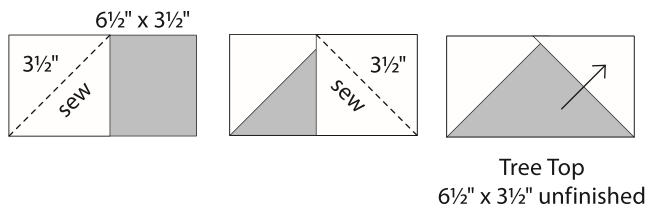

(B) Draw a diagonal line from corner to corner on the wrong side of 14–2" background squares. Layer 2" marked background square, right sides to together, on 1–6 1/2" x 2" tree rectangle as shown. Sew on the diagonal line. Trim 1/4" from the sewn line. Press to reveal the triangle. Repeat on the opposite end of the same rectangle. Make 7.

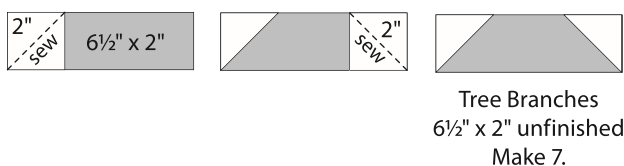

3 Assemble the block as shown.

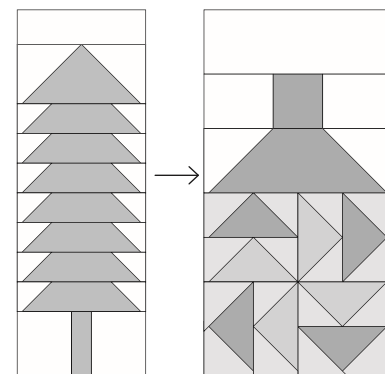

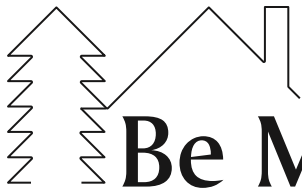

moda

Be My Neighbor

Block 8

15" x 18" finished

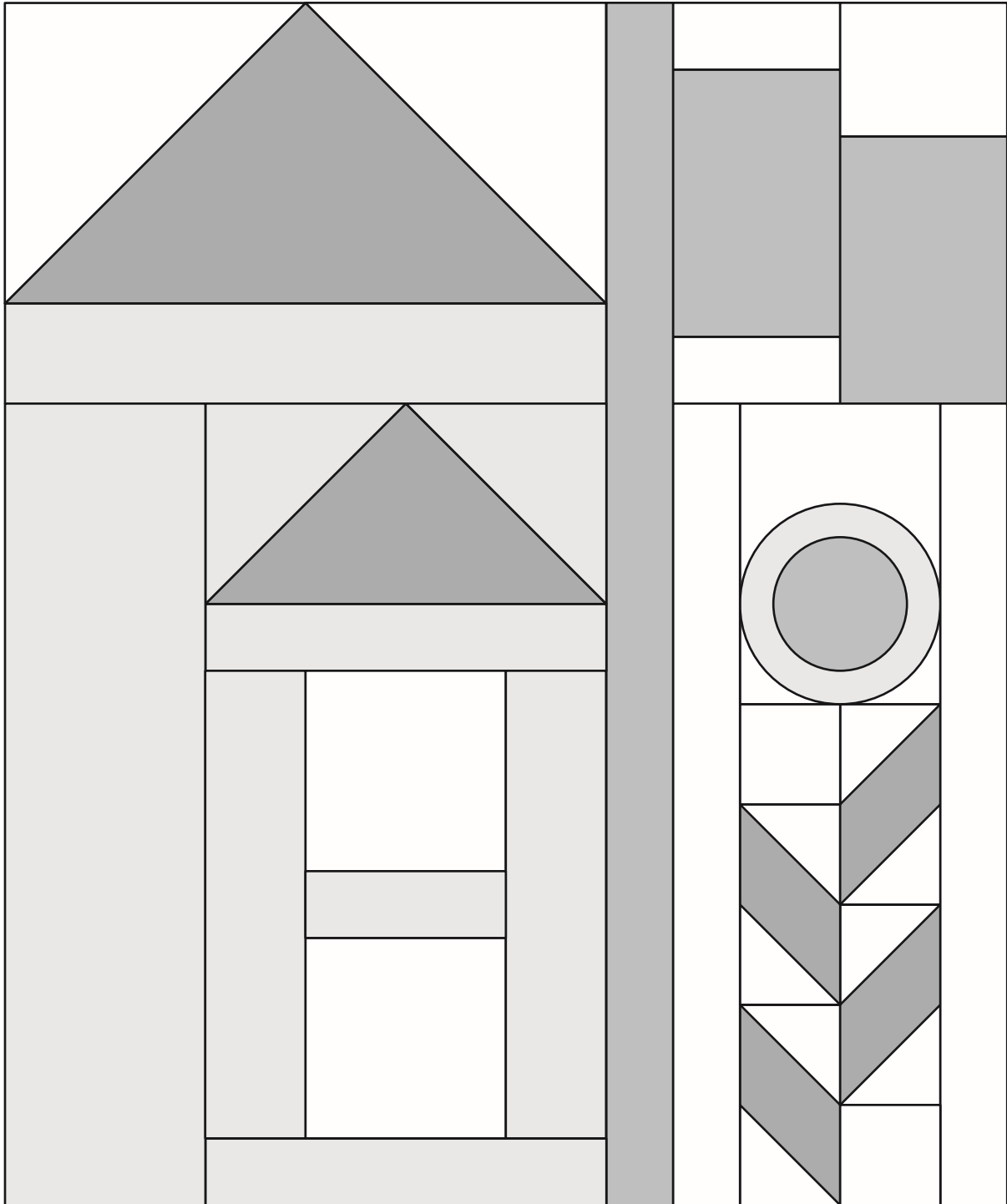

General Information

- These are very scrappy blocks. Mix your favorite Moda prints to create your colorful neighborhood!
- Share your progress and final quilt at #BeMyNeighbor. We love to see your results!!!

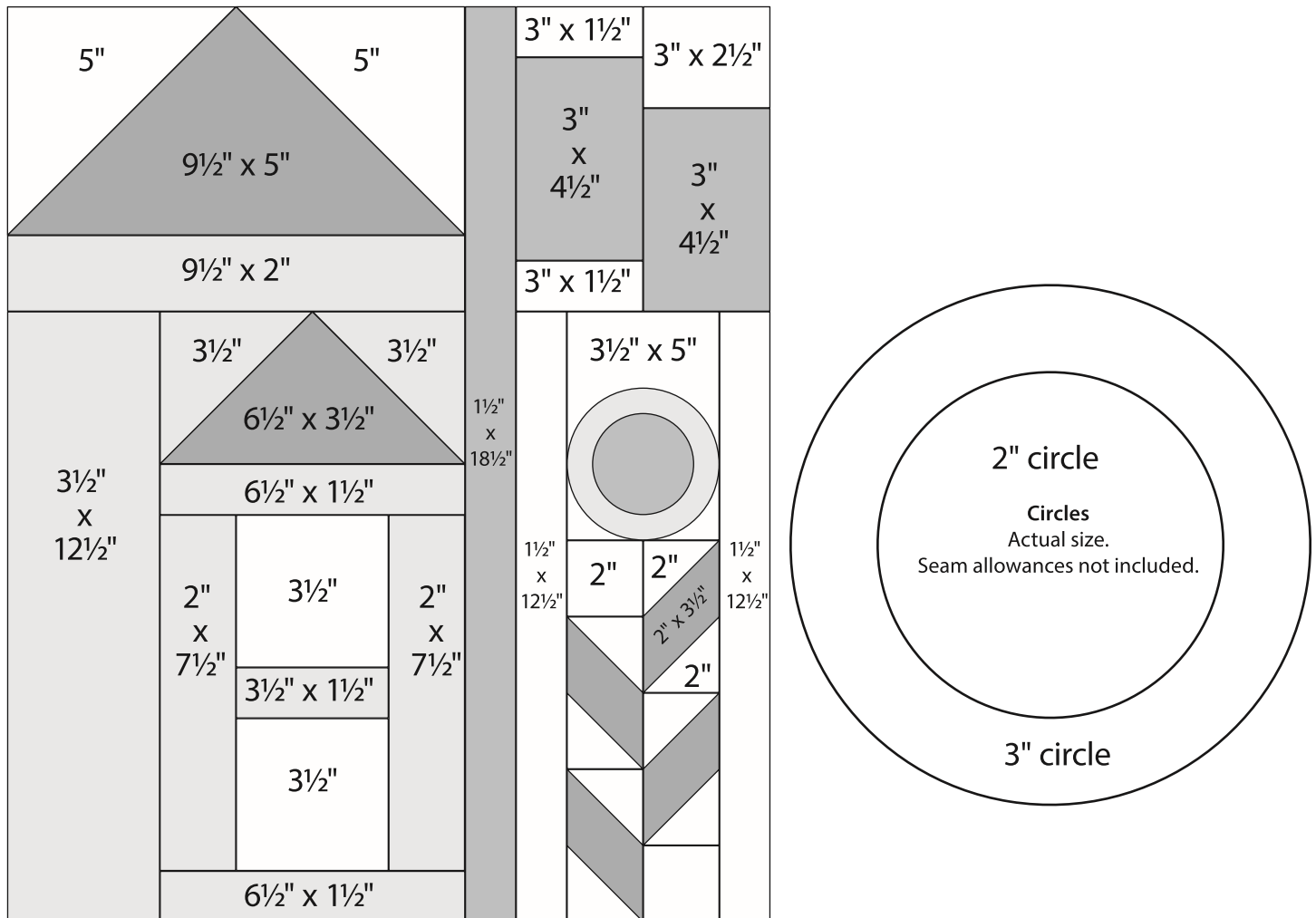

Block 8
15½" x 18½" unfinished

Cutting

Leaves

4–2" x 3½" rectangles

Flowers

2 circles

Roof

1–9½" x 5" rectangle

1–6½" x 3½" rectangle

Flag

2–3" x 4½" rectangles

Flag Pole

1–1½" x 18½" rectangle

Window

2–3½" squares

House

1–9½" x 2" rectangle

2–6½" x 1½" rectangles

1–3½" x 12½" rectangle

1–3½" x 1½" rectangle

2–3½" squares

2–2" x 7½" rectangles

Background

2–5" squares

1–3½" x 5" rectangle

2–3" x 1½" rectangles

1–3" x 2½" rectangle

10–2" squares

2–1½" x 12½" rectangles



moda Be My Neighbor

Block 8 is 15" x 18" finished.

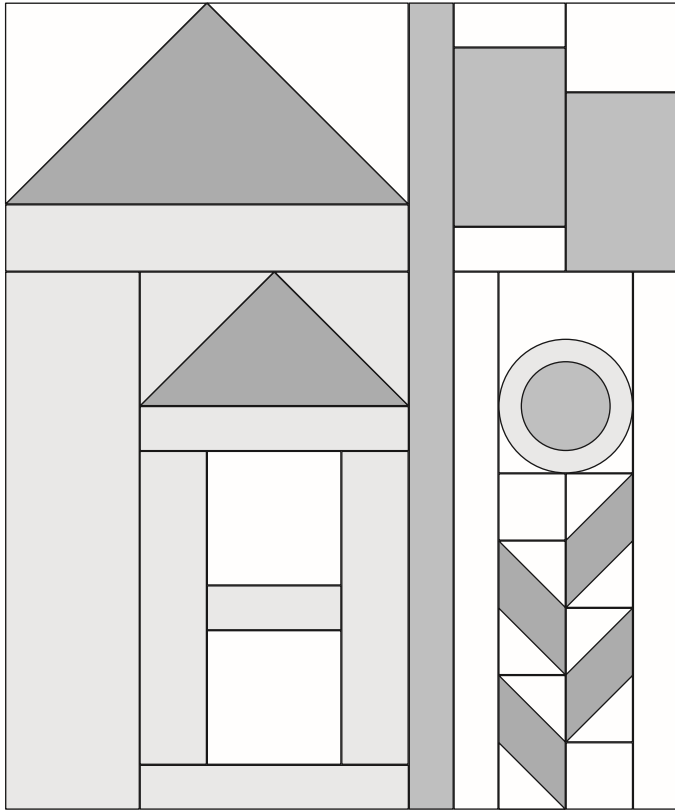

- 2 House Roof Small**
 Draw a diagonal line from corner to corner on the wrong side of 2-3½" house squares. Layer a 3½" marked house square, right sides to together, on 1-6½" x 3½" small roof rectangle as shown. Sew, trim, and press. Repeat on the the opposite end of the same rectangle. Make 1.

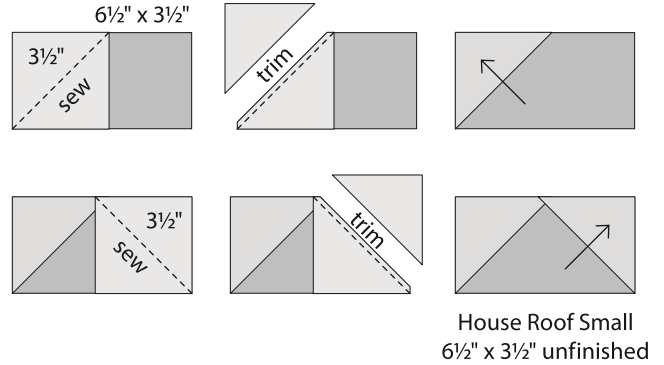

- 3 Assemble the house as shown.**

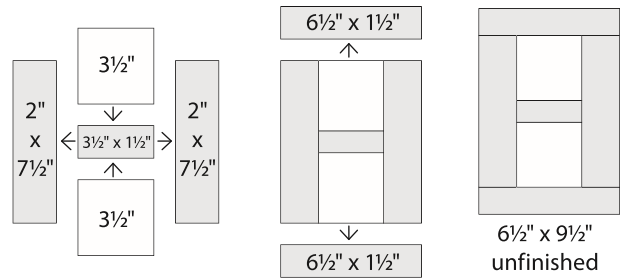

Construction

Use ¼" seams. Press in the direction of the arrows in the diagrams.

- 1 House Roof Large**
 Draw a diagonal line from corner to corner on the wrong side of 2-5" background squares. Layer a 5" marked background square, right sides to together, on 1-9½" x 5" roof rectangle as shown. Sew on the diagonal line. Trim ¼" from the sewn line. Press to reveal the triangle. Repeat on the the opposite end of the same rectangle. Make 1.

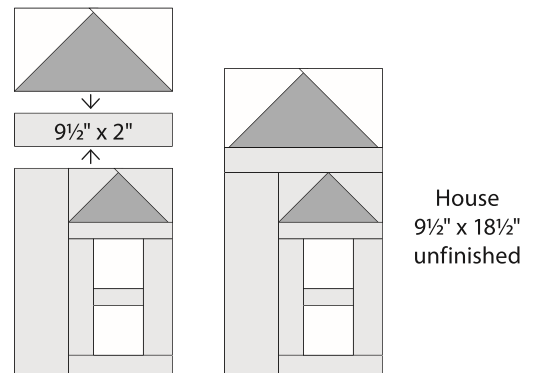
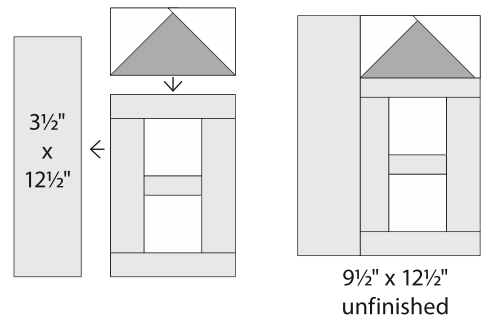
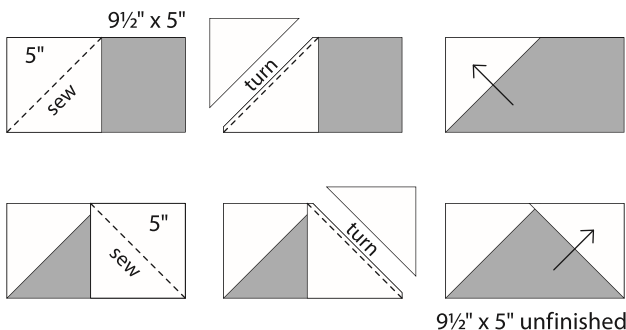

4 Flower

(A) Draw a diagonal line from corner to corner on the wrong side of 8-2" background squares. Layer a 2" marked background square, right sides to together, on 1-2" x 3 1/2" leaf rectangle as shown. Sew on the diagonal line. Trim 1/4" from the sewn line. Press to reveal the triangle. Repeat on the the opposite end of the same rectangle. Make 2 leaf As and 2 leaf Bs. *Note the 2" square placement is different.*

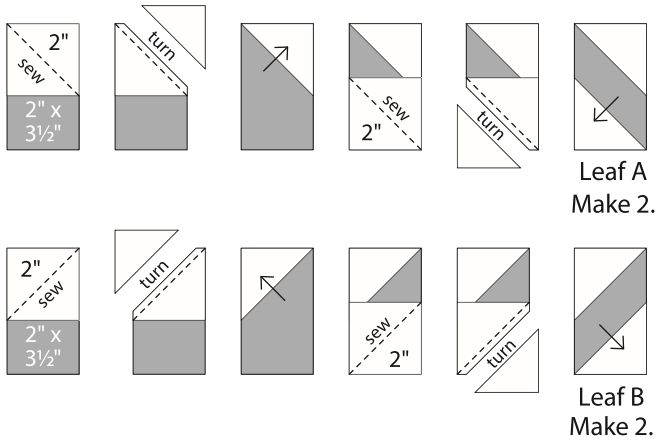

(B) Arrange and sew 2-Leaf As and 1-2" background square to make column A. Arrange sew 1-2" background square and sew 2-Leaf Bs to make column B. Join the columns, add a 3 1/2" x 5" background rectangle. Add 2-1 1/2" x 12 1/2" background rectangles. Use you appliqué method of choice to add the circles.

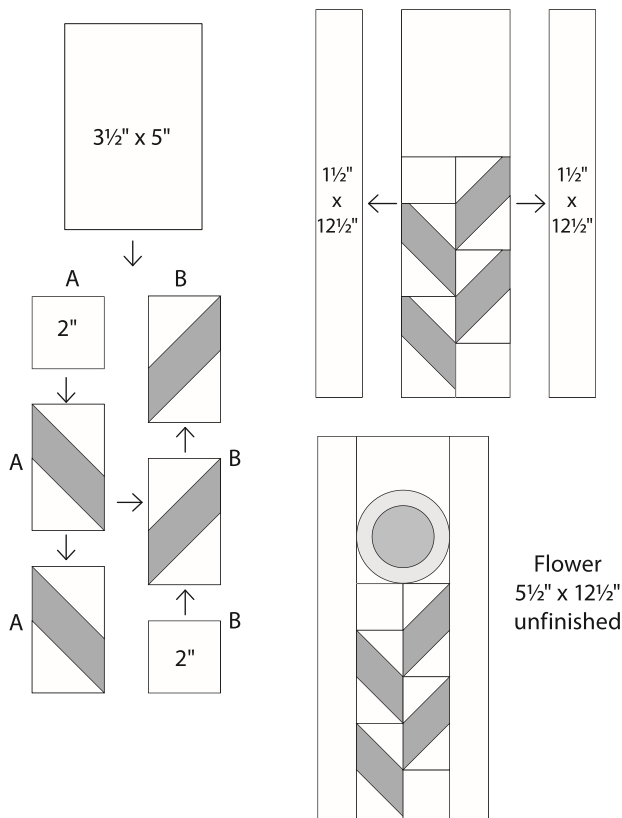

5 Assemble the flag as shown.

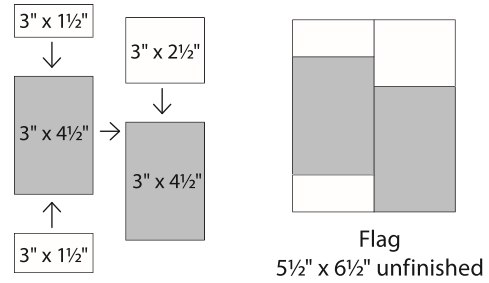

moda

6 Assemble the block as shown.

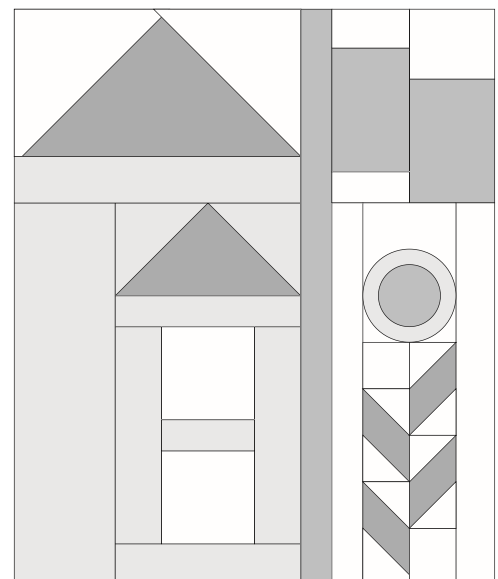
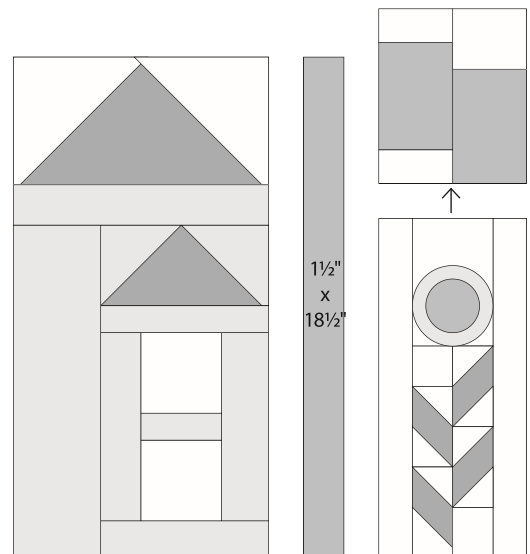

Block 8
15 1/2" x 18 1/2" unfinished



moda

Be My Neighbor

Block 9
15" x 18" finished

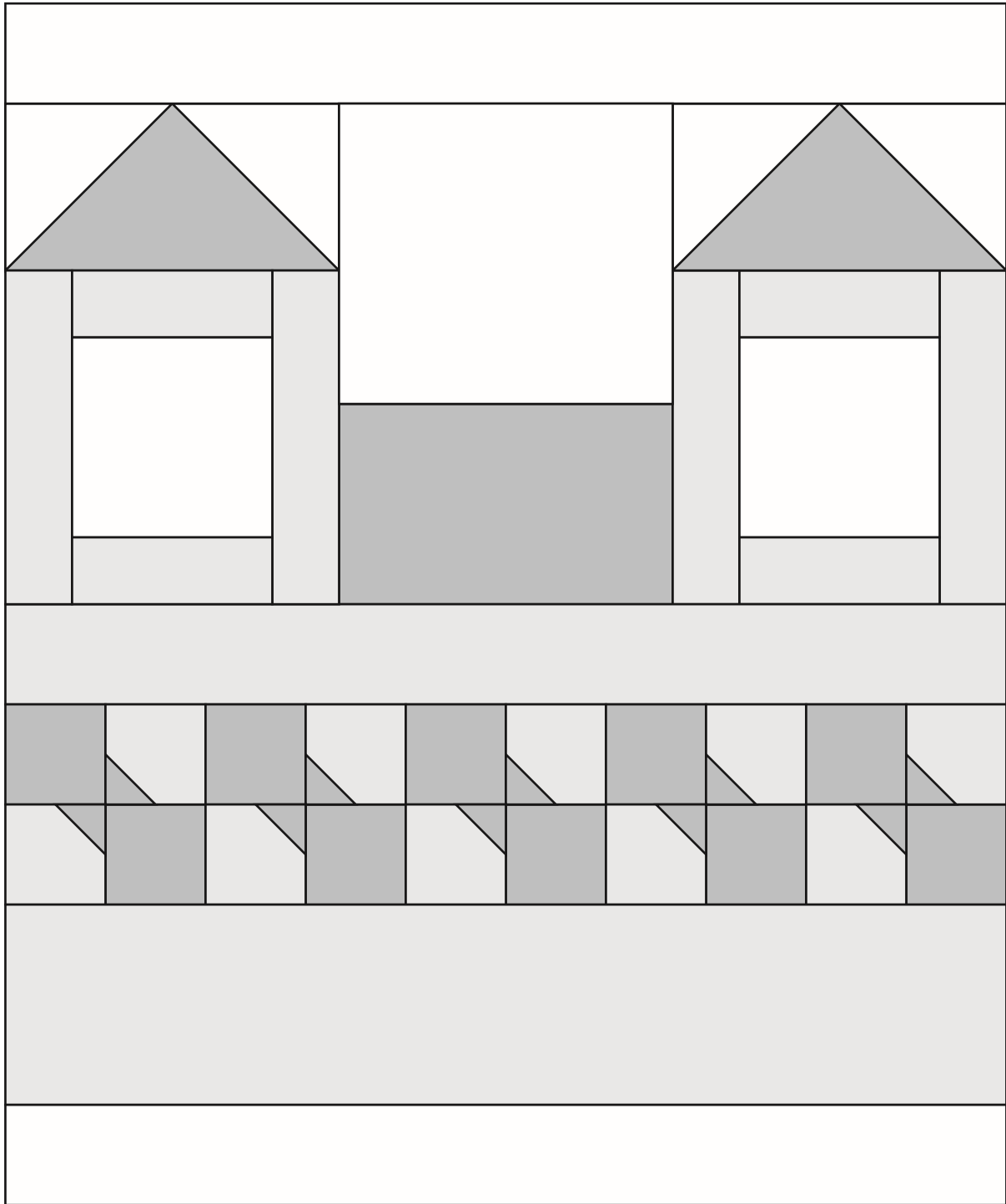

General Information

- These are very scrappy blocks. Mix your favorite Moda prints to create your colorful neighborhood!
- Share your progress and final quilt at #BeMyNeighbor. We love to see your results!!!

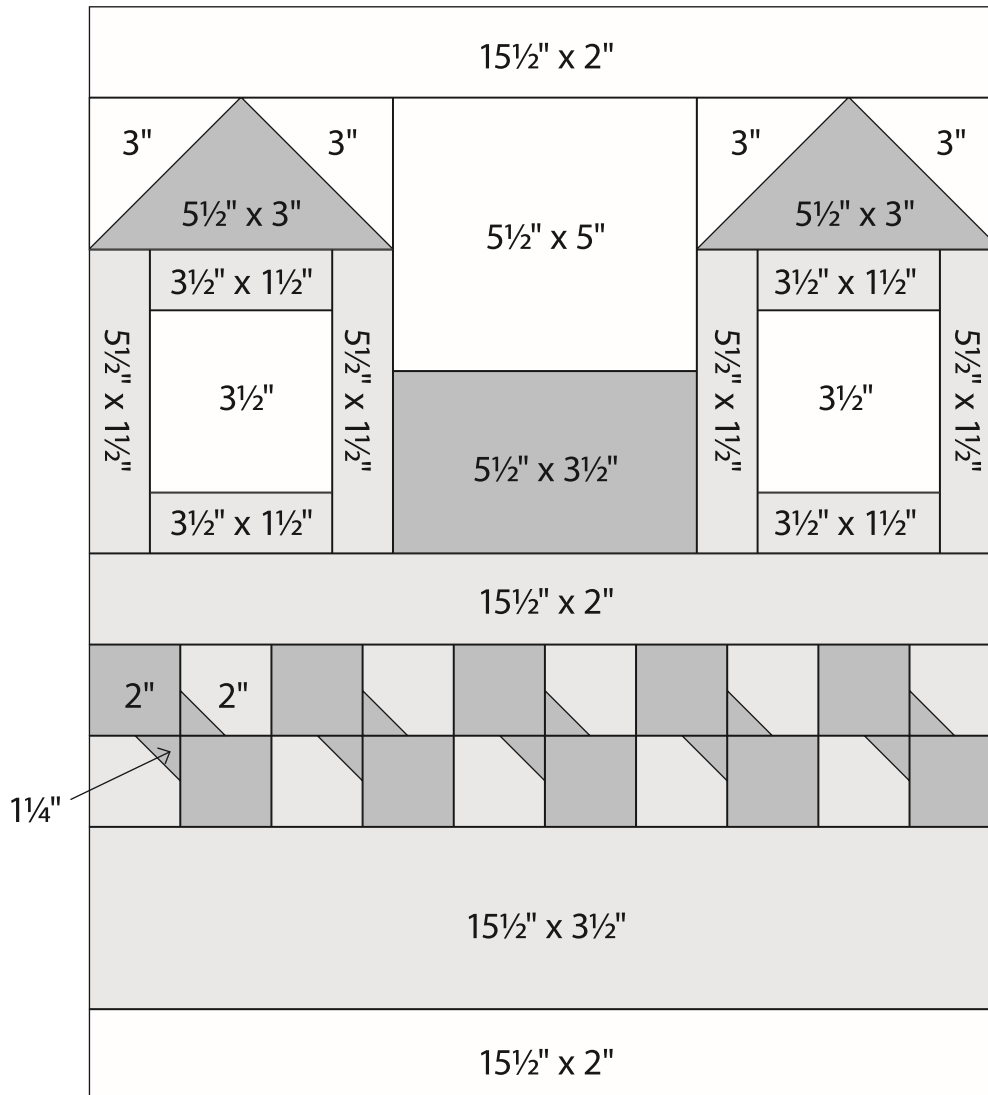

Block 9
15 1/2" x 18 1/2" unfinished

Cutting

House Roof

- 1-5 1/2" x 3 1/2" rectangle
- 2-5 1/2" x 3" rectangles

Bowties (5 total)

- For EACH bowtie cut
- 2-2" squares and 2-1 1/4" squares

Windows

- 2-3 1/2" squares

House

- 1-15 1/2" x 3 1/2" rectangle
- 1-15 1/2" x 2" rectangle
- 10-2" squares
- 4-5 1/2" x 1 1/2" rectangles
- 4-3 1/2" x 1 1/2" rectangles

Background

- 2-15 1/2" x 2" rectangles
- 1-5 1/2" x 5" rectangles
- 4-3" squares

Be My Neighbor

Block 9 is 15" x 18" finished.

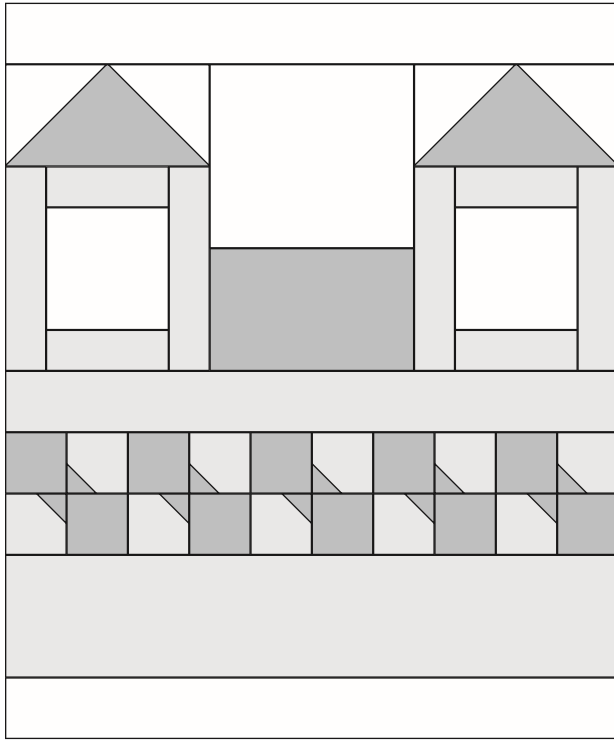

House Rooftops and Windows continued . . .

(B) Assemble windows and rooftops as shown.

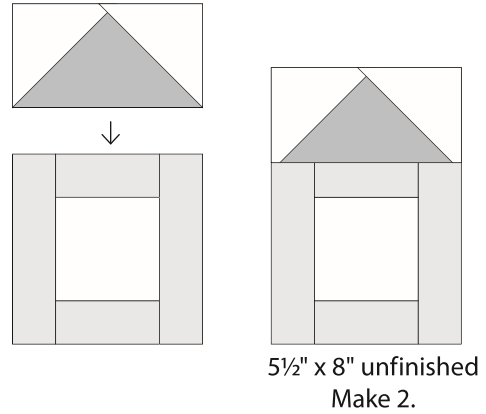
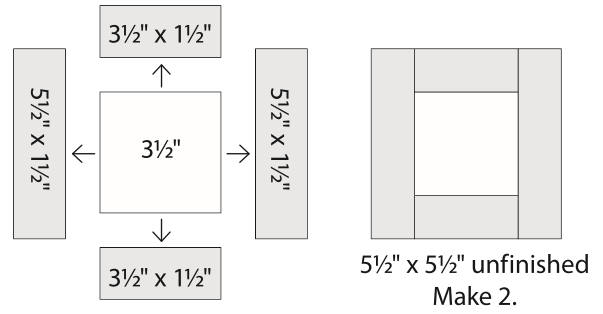

Construction

Use 1/4" seams. Press in the direction of the arrows in the diagrams.

1 House Rooftops and Windows

(A) Draw a diagonal line from corner to corner on the wrong side of 4-3" background squares. Layer a 3" marked background square, right sides to together, on 1-5 1/2" x 3" roof rectangle as shown. Sew on the diagonal line. Trim 1/4" from the sewn line. Press to reveal the triangle. Repeat on the opposite end of the same rectangle. Make 2.

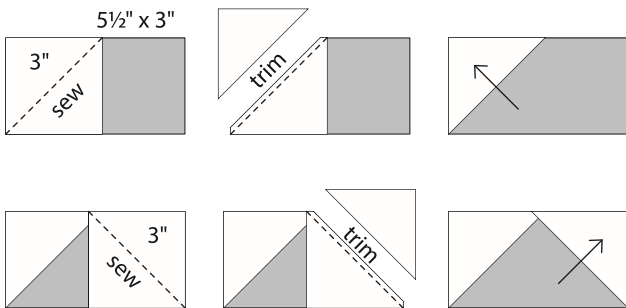

House
5 1/2" x 3" unfinished
Make 2.

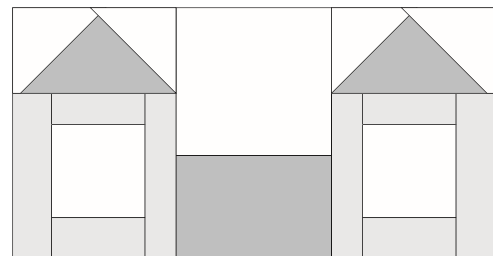
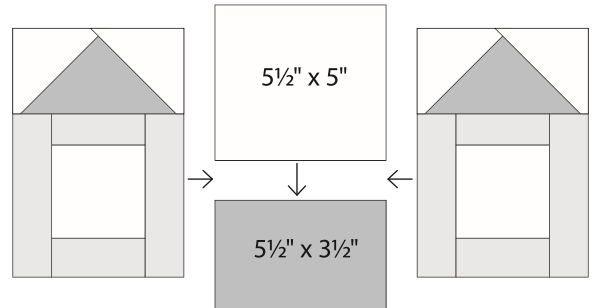

15 1/2" x 8" unfinished

2 To make one Bowtie

(A) Draw a diagonal line from corner to corner on the wrong side of 2-1 1/4" bowtie squares. Layer a 1 1/4" marked bowtie square, right sides together, on 1-2" house square as shown. Sew on the diagonal line. Trim 1/4" from the sewn line. Press to reveal the triangle.

Make 2.

Arrange and sew 2 rows of 1-2" bowtie square and 1 bowtie as shown. Join the rows. Repeat to make bowties.

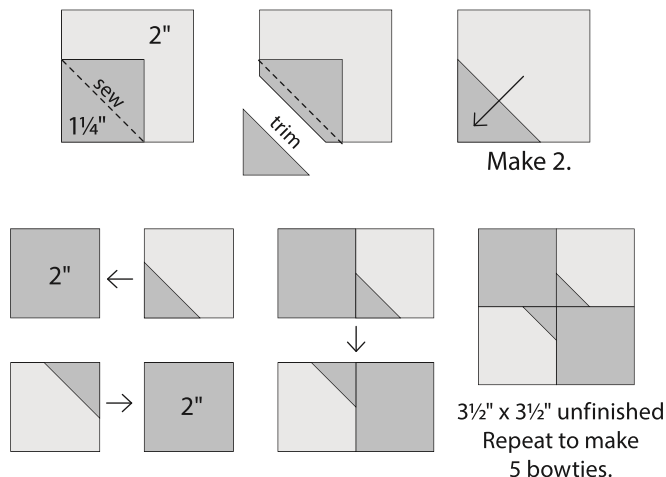

(B) Join the 5 bowties in one row.

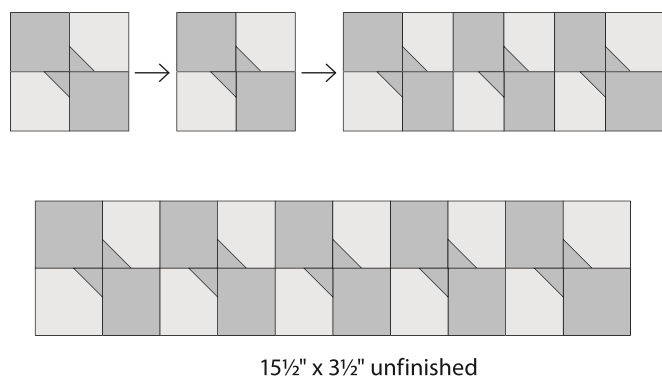

moda

3 Assemble the block as shown.

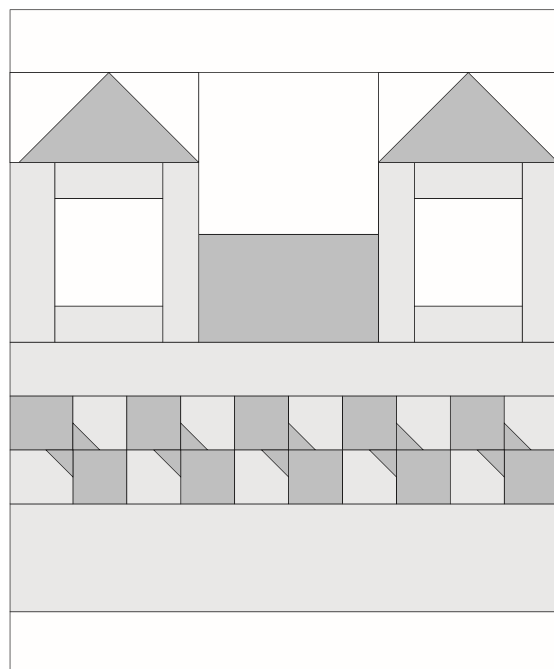
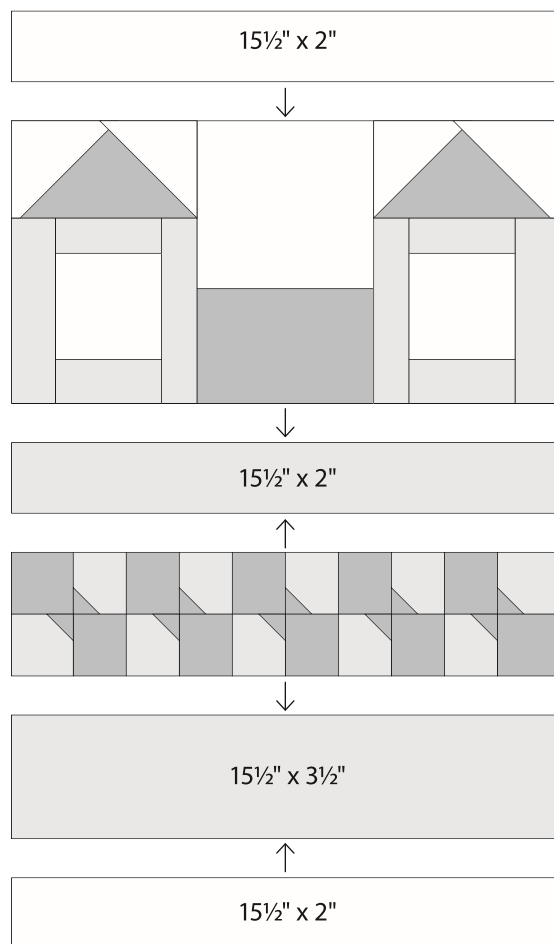

Block 9
 15 1/2" x 18 1/2" unfinished

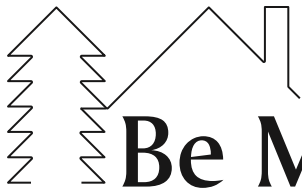

moda

Be My Neighbor

Block 10

15" x 18" finished

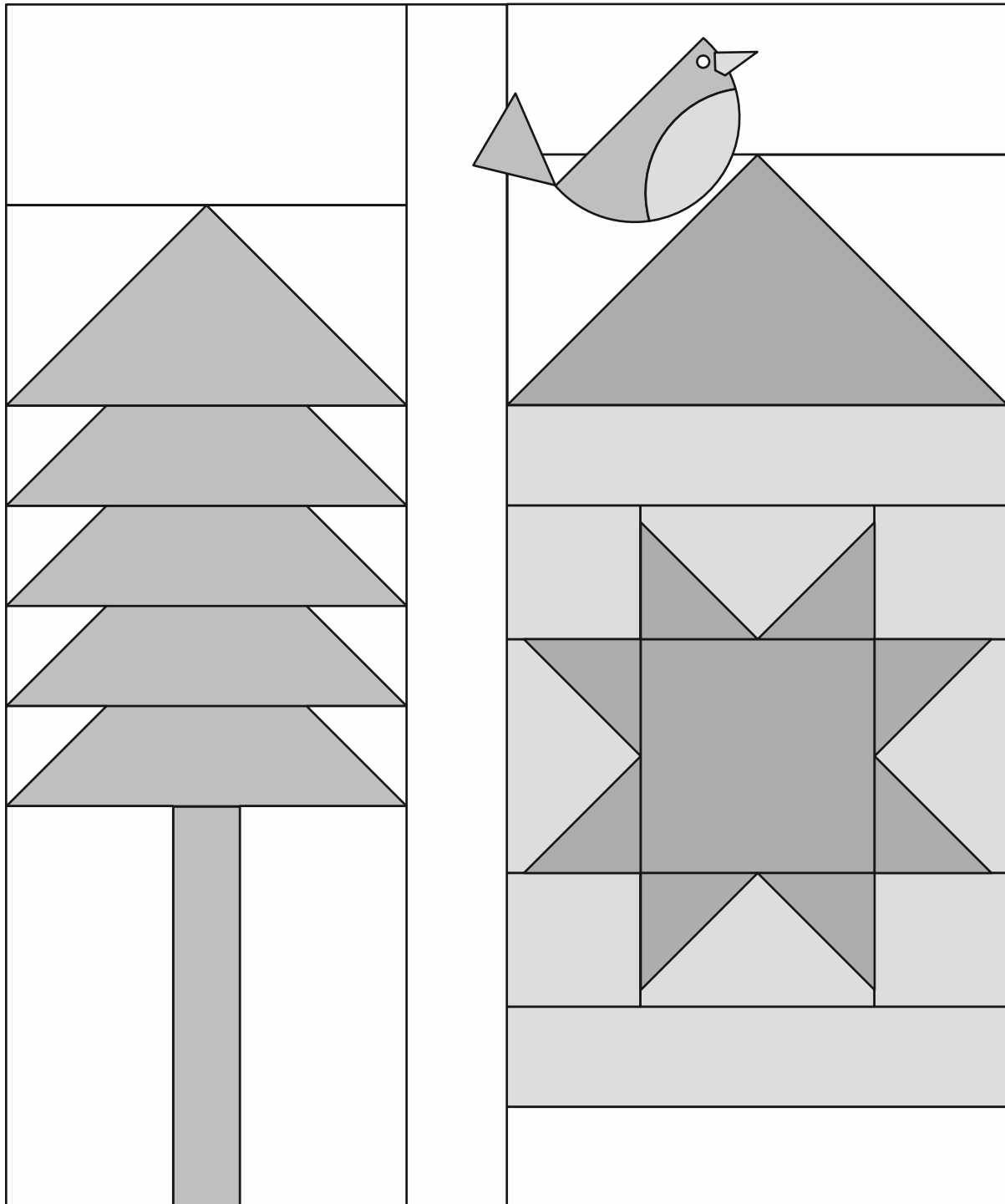

General Information

- These are very scrappy blocks. Mix your favorite Moda prints to create your colorful neighborhood!
- Share your progress and final quilt at #BeMyNeighbor. We love to see your results!!!

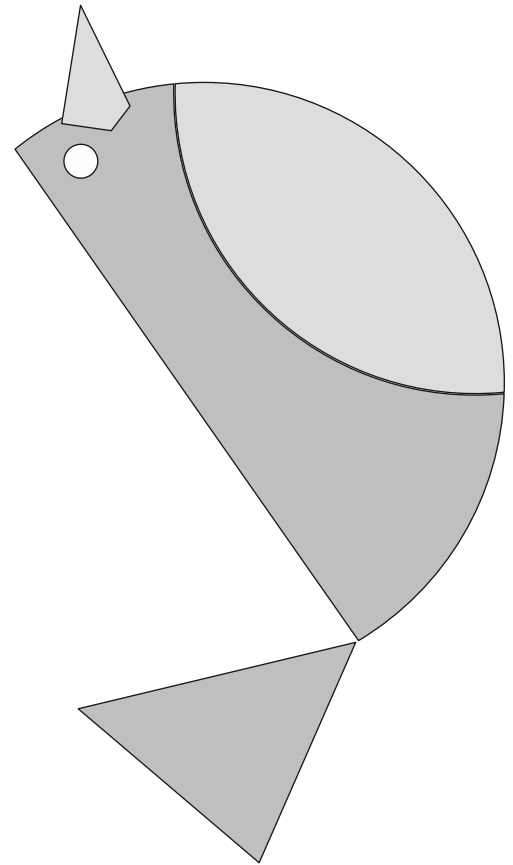
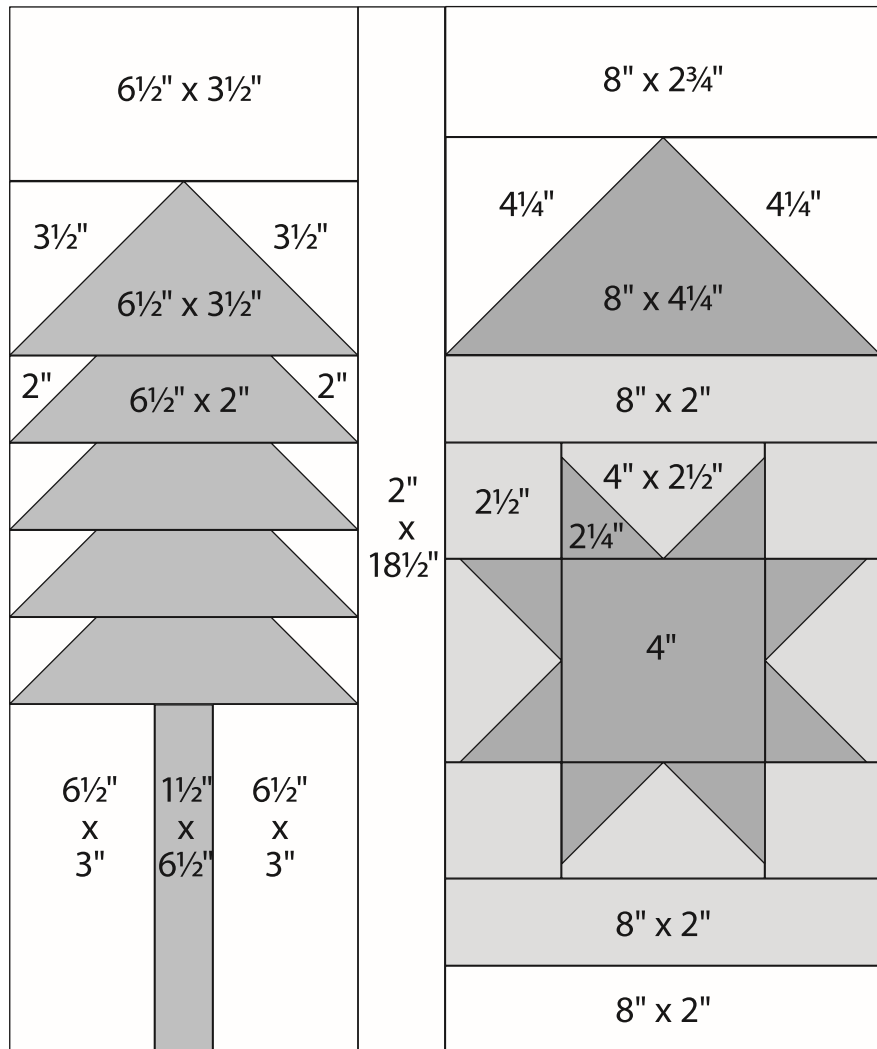

Bird Appliqué
Actual size.
Seam allowances not included.
Not reversed.

Block 10
15 1/2" x 18 1/2" unfinished

Cutting

Tree

1-6 1/2" x 3 1/2" rectangle
4-6 1/2" x 2" rectangles

Tree Trunk

1-1 1/2" x 6 1/2" rectangle

Star

1-4" square
8-2 1/4" squares

House Roof

1-8" x 4 1/4" rectangle

House

2-8" x 2" rectangles
4-4" x 2 1/2" rectangles
4-2 1/2" squares

Bird Appliqué

1-beak
1-body
1-tail
1-wing
1-eye

Background

1-8" x 2 3/4" rectangle
1-8" x 2" rectangle
1-6 1/2" x 3 1/2" rectangle
2-4 1/4" squares
2-3 1/2" squares
2-3" x 6 1/2" rectangles
1-2" x 18 1/2" rectangle
8-2 squares

Be My Neighbor

Block 10 is 15" x 18" finished.

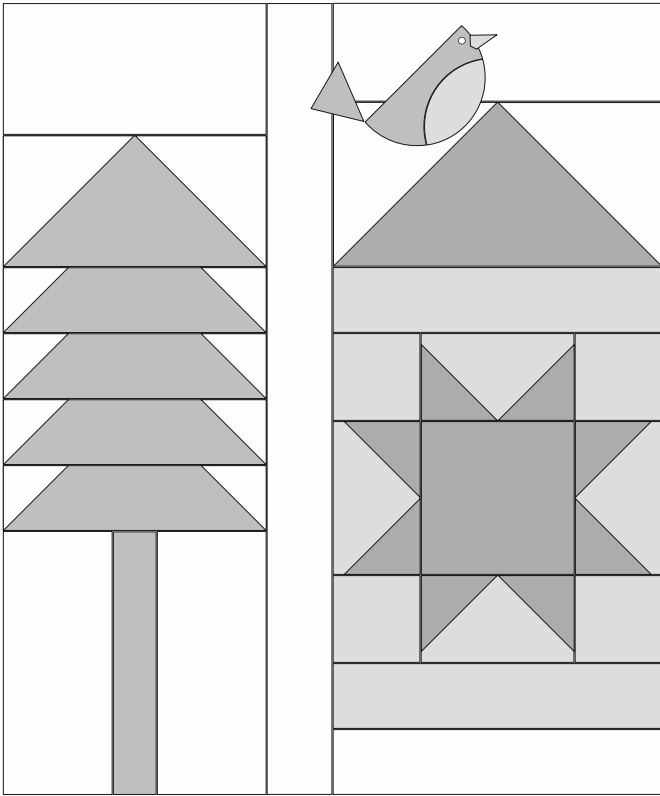

Construction

Use $\frac{1}{4}$ " seams. Press in the direction of the arrows in the diagrams.

1 Tree

(A) Draw a diagonal line from corner to corner on the wrong side of $2-3\frac{1}{2}$ " background squares. Layer a $3\frac{1}{2}$ " marked background square, right sides to together, on $1-6\frac{1}{2}$ " x $3\frac{1}{2}$ " tree rectangle as shown. Sew on the diagonal line. Trim $\frac{1}{4}$ " from the sewn line. Press to reveal the triangle. Repeat on the opposite end of the same rectangle. Make 1.

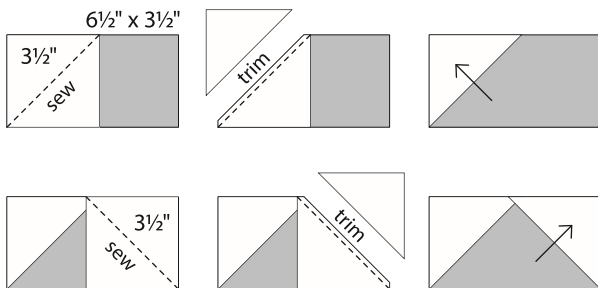

Tree Top
 $6\frac{1}{2}$ " x $3\frac{1}{2}$ " unfinished

tree continued . . .

(B) Draw a diagonal line from corner to corner on the wrong side of $8-2$ " background squares. Layer a 2 " marked background square, right sides to together, on both ends of a $1-6\frac{1}{2}$ " x 2 " tree rectangle as shown. Sew on the diagonal lines. Trim $\frac{1}{4}$ " from the sewn lines. Press to reveal the triangles. Make 4.

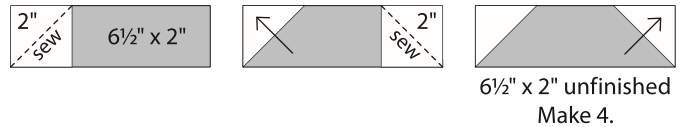

$6\frac{1}{2}$ " x 2 " unfinished
Make 4.

(C) Assemble the tree as shown.

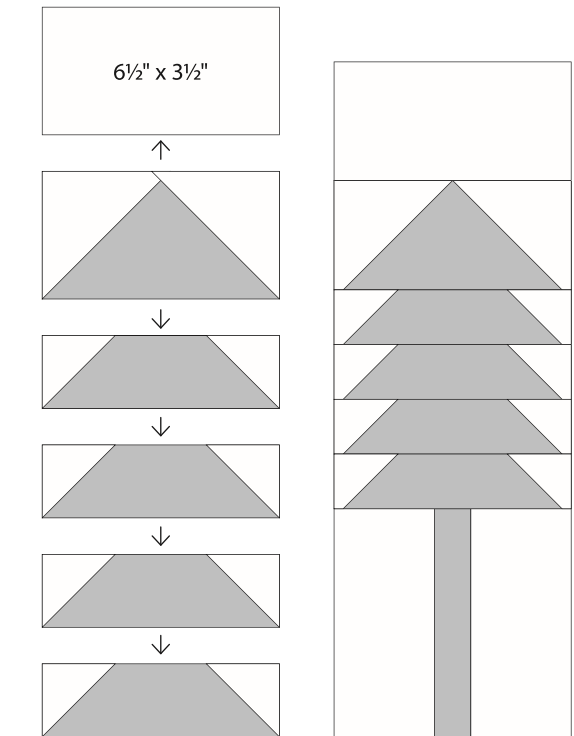

Tree
 $6\frac{1}{2}$ " x $18\frac{1}{2}$ " unfinished

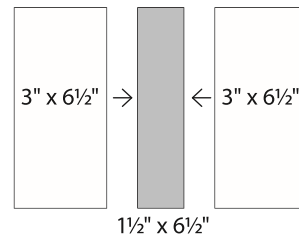

moda

2 House

(A) Draw a diagonal line from corner to corner on the wrong side of 2-4 1/4" background squares. Layer a 4 1/4" marked background square, right sides to together, on 1-8" x 4 1/4" roof rectangle as shown. Sew on the diagonal line. Trim 1/4" from the sewn line. Press to reveal the triangle. Repeat on the opposite end of the same rectangle. Make 1.

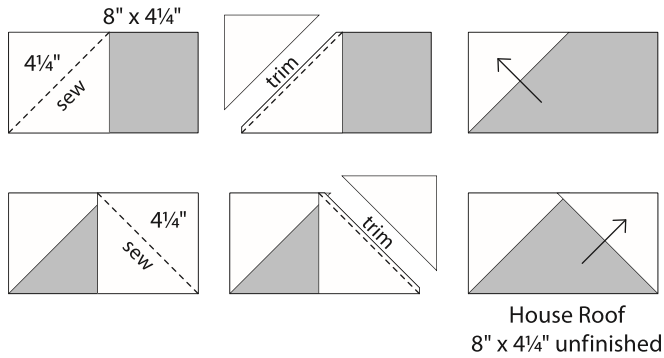

(B) Draw a diagonal line from corner to corner on the wrong side of 8-2 1/4" star point squares. Layer 2 1/4" marked star point square, right sides to together, on 1-4" x 2 1/2" house rectangle as shown. Sew on the diagonal line. Trim 1/4" from the sewn line. Press to reveal the triangle. Repeat on the opposite end of the same rectangle. Make 4 star points.

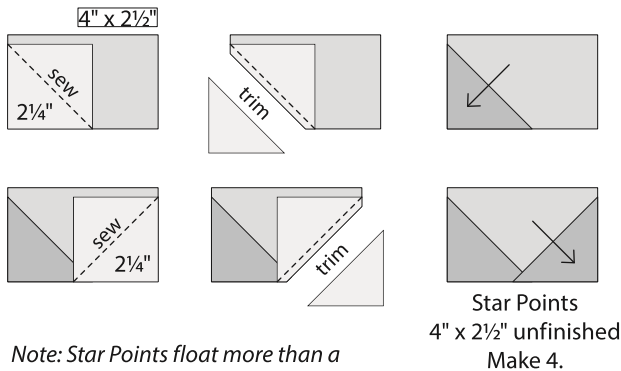

Note: Star Points float more than a 1/4" from the edges.

(C) Assemble the star as shown.

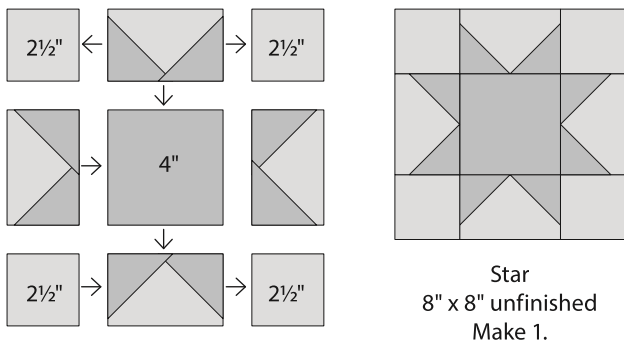

3 Assemble the block as shown. Use fusible web and a zig zag or blanket stitch to add the bird to the completed house block.

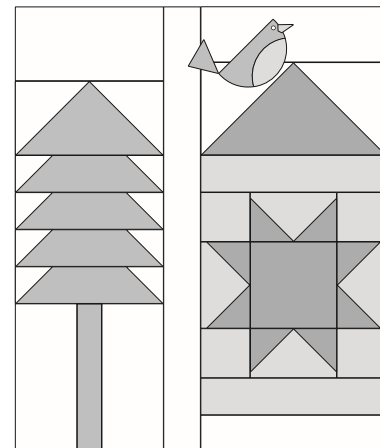
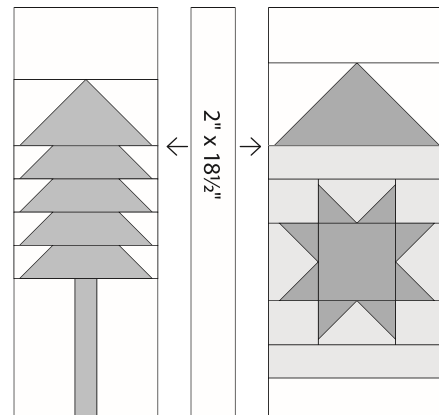
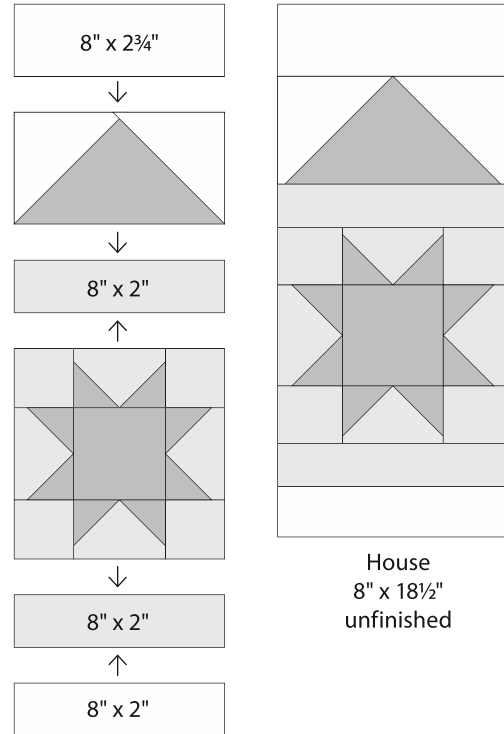

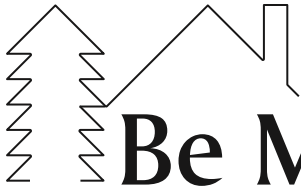

moda

Be My Neighbor

Block 11

21" x 18" finished

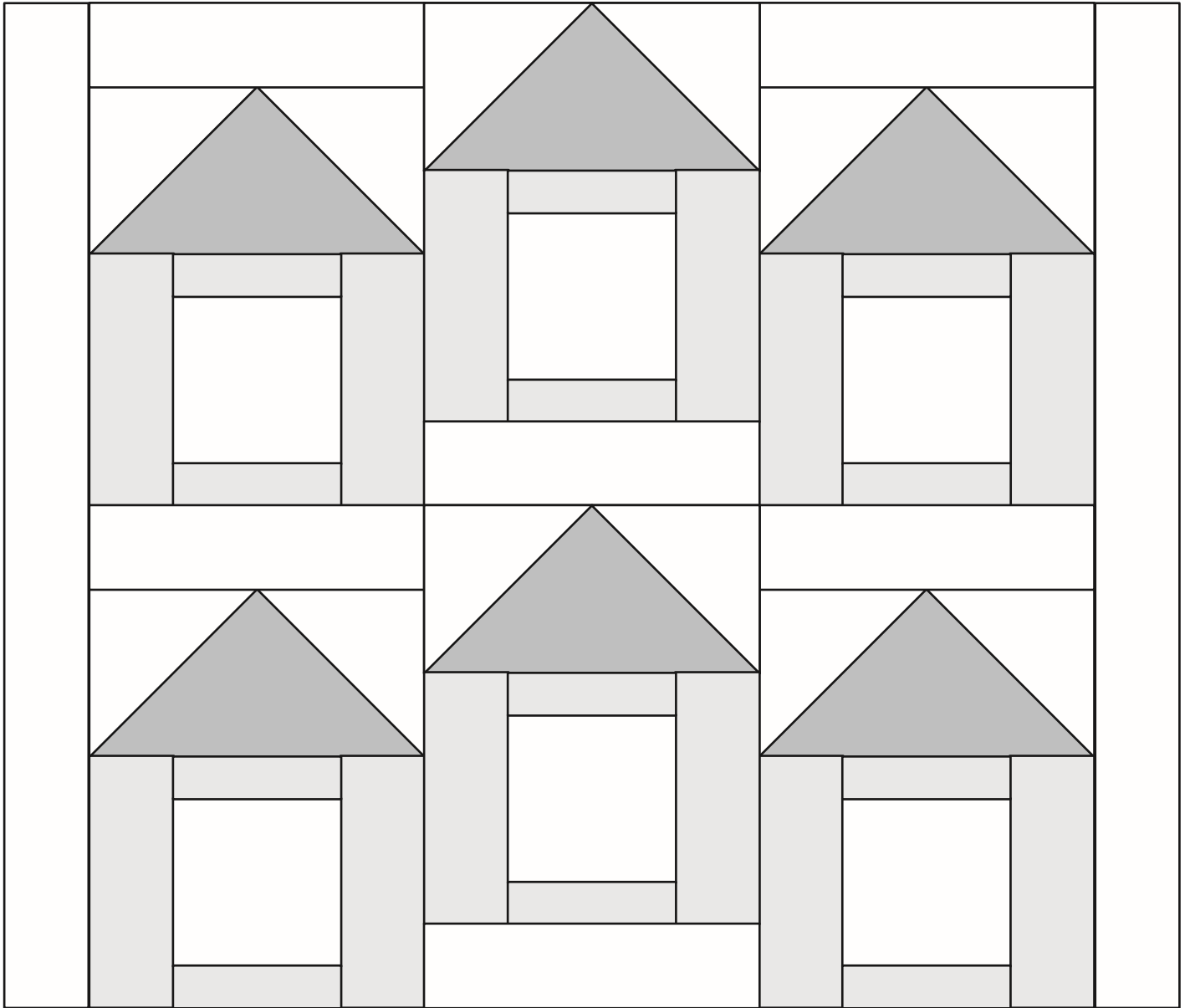

General Information

- These are very scrappy blocks. Mix your favorite Moda prints to create your colorful neighborhood!
- Share your progress and final quilt at #BeMyNeighbor. We love to see your results!!!

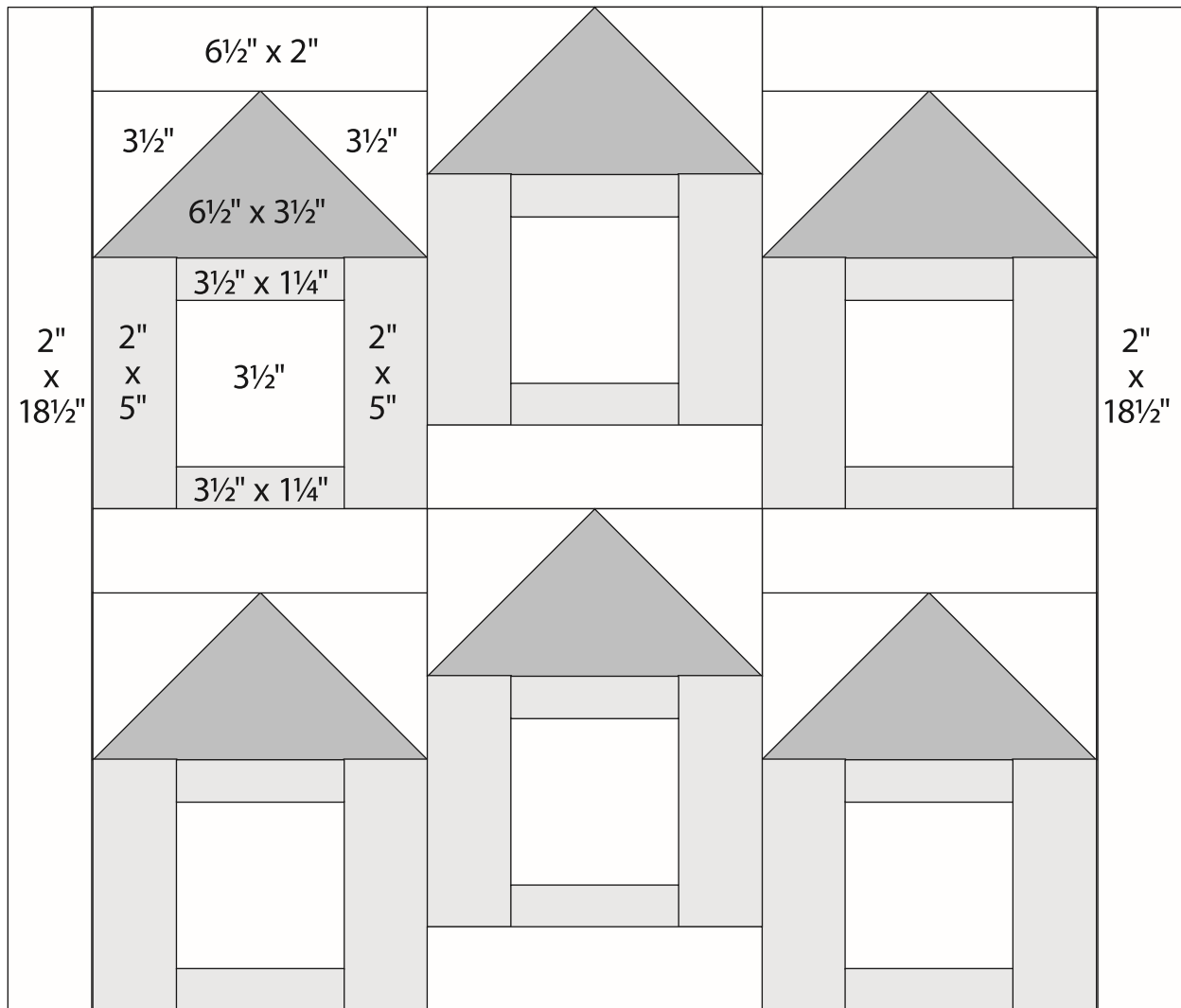

Block 11
21½" x 18½" unfinished

Cutting

House Roof

6–6½" x 3½" rectangles

Window

6–3½" squares

House

12–5" x 2" rectangles

12–3½" x 1¼" rectangles

Background

6–6½" x 2" rectangles

12–3½" squares

2–2" x 18½" rectangles

moda



moda
Be My Neighbor

Block 11 is 21" x 18" finished.

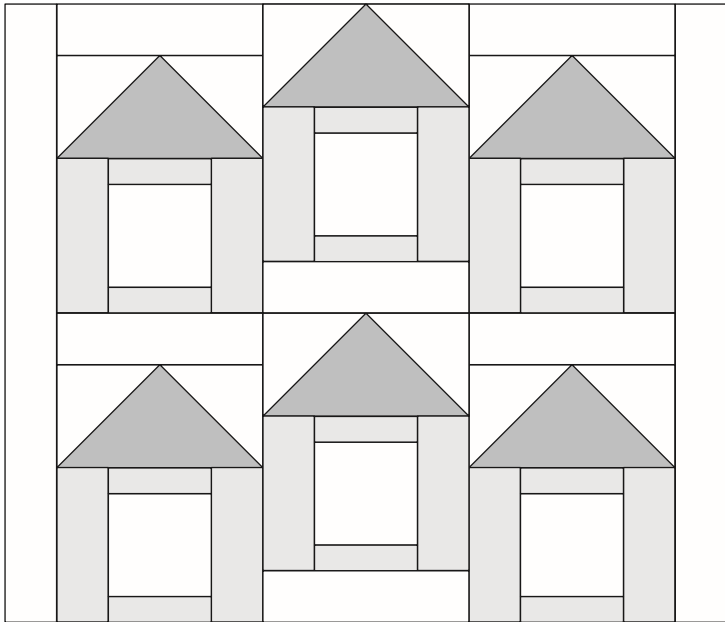

Construction

Use 1/4" seams. Press in the direction of the arrows in the diagrams.

- 1 House Roof**
Draw a diagonal line from corner to corner on the wrong side of 12-3/2" background squares. Layer a 3-1/2" marked background square, right sides together, on 1-6-1/2" x 3-1/2" roof rectangle as shown. Sew on the diagonal line. Trim 1/4" from the sewn line. Press to reveal the triangle. Repeat on the the opposite end of the same rectangle. Make 6.

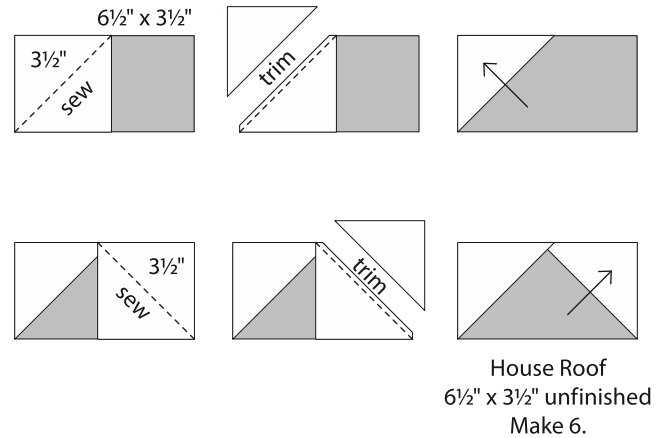

- 2 Assemble the house as shown.**

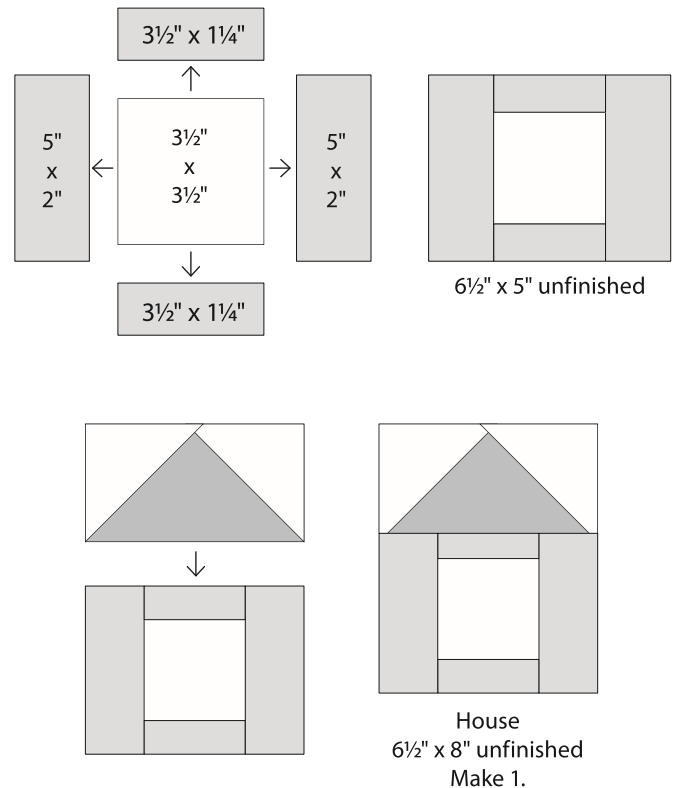

moda

3 Assemble the block as shown.

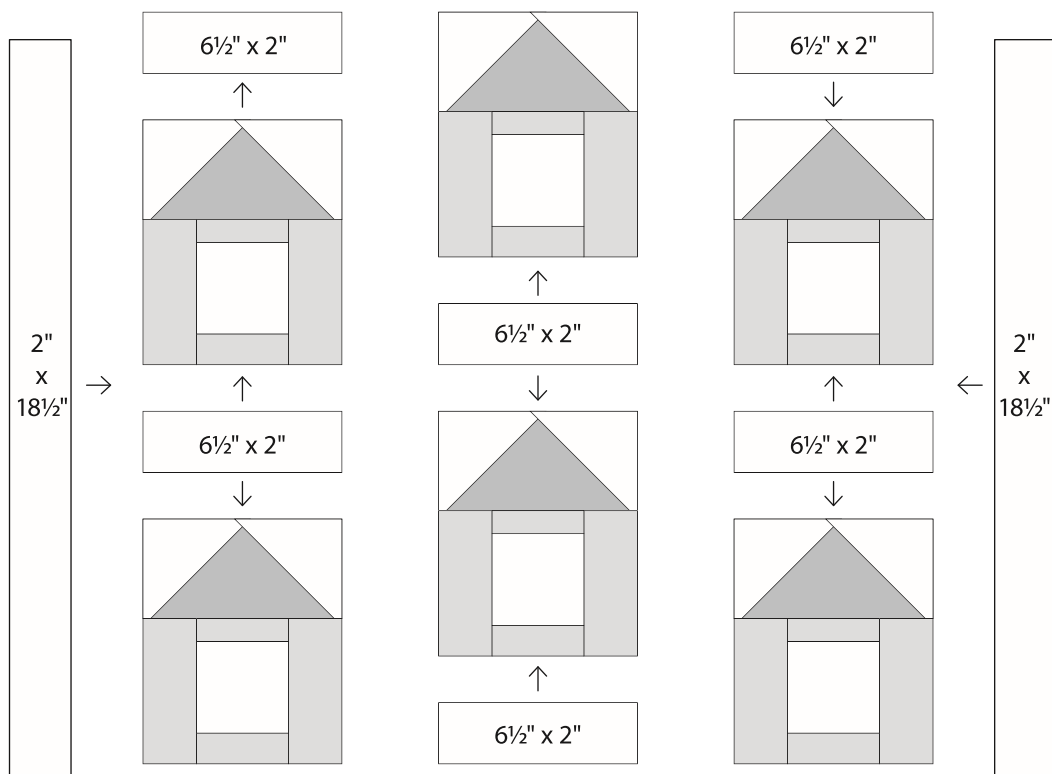

moda

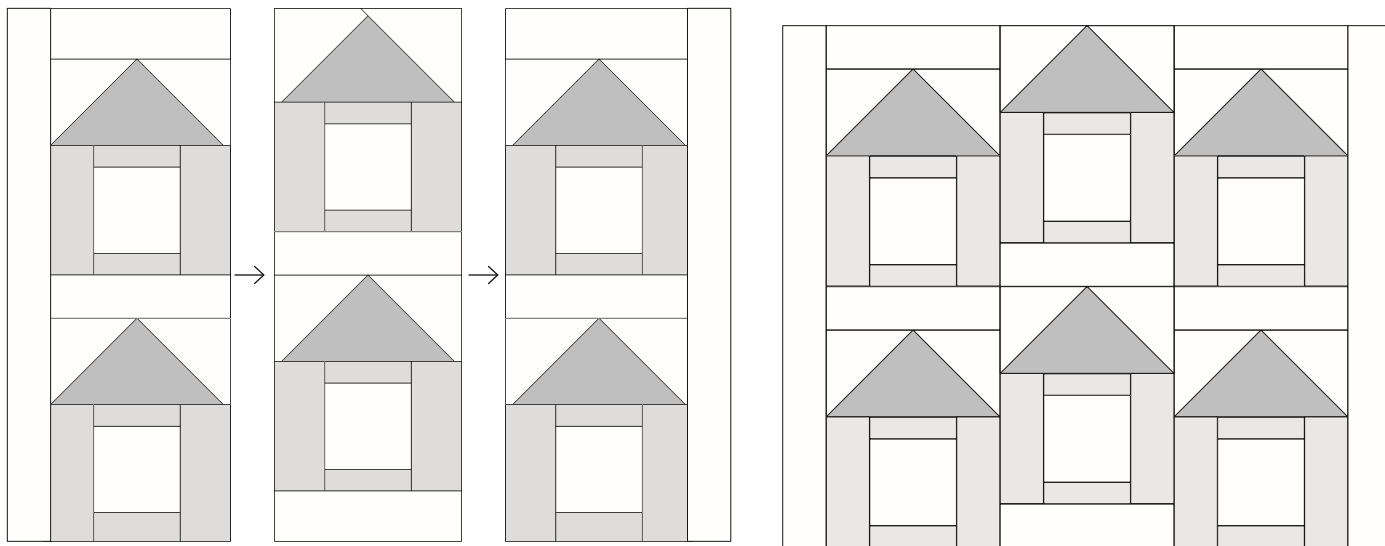

Block 11
21 1/2" x 18 1/2" unfinished



moda

Be My Neighbor

Block 12

9" x 18" finished

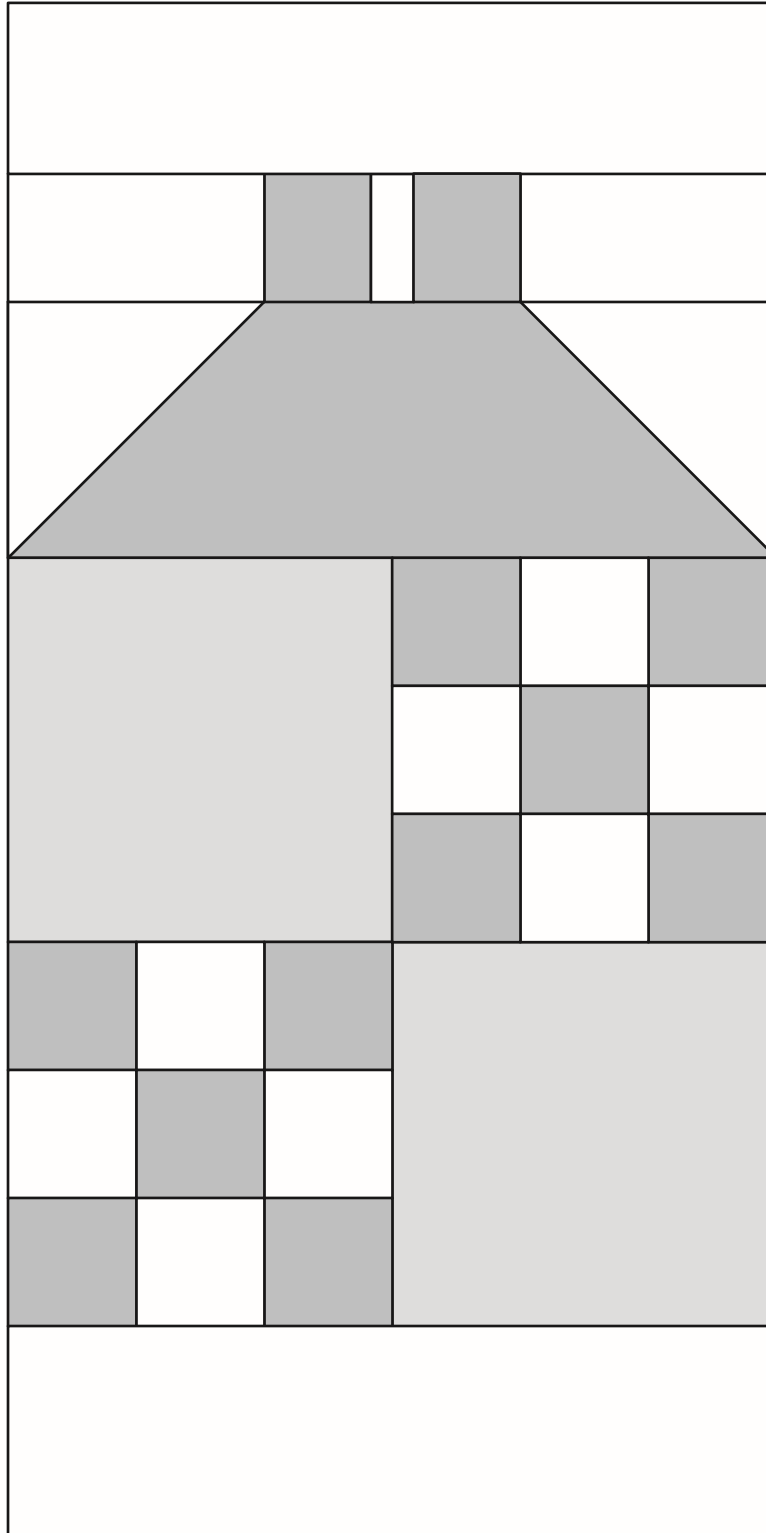

General Information

- These are very scrappy blocks. Mix your favorite Moda prints to create your colorful neighborhood!
- Share your progress and final quilt at #BeMyNeighbor. We love to see your results!!!

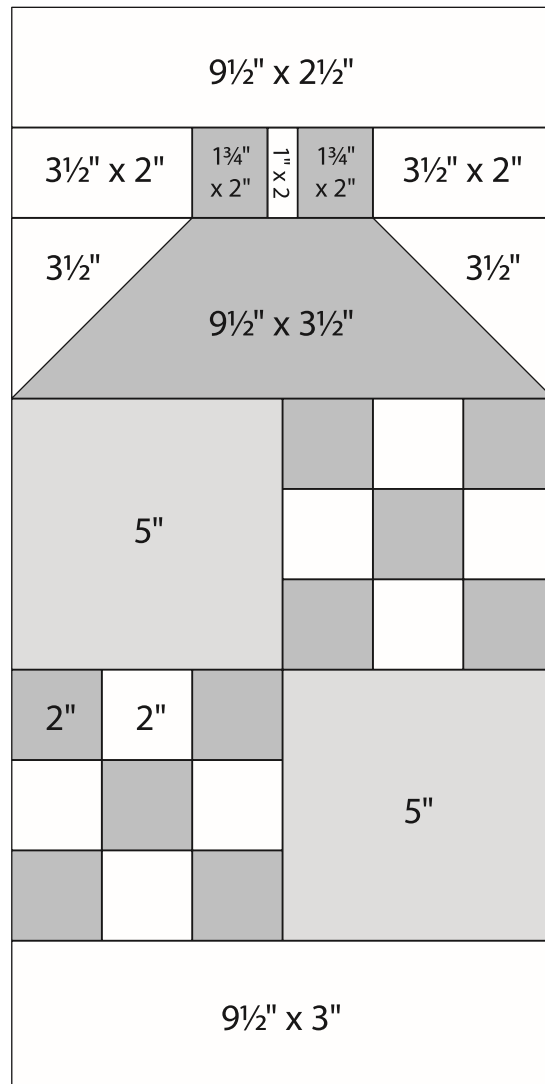

Block 12
 $9\frac{1}{2}'' \times 18\frac{1}{2}''$ unfinished

Cutting

House Roof

1- $9\frac{1}{2}'' \times 3\frac{1}{2}''$ rectangle

House

2-5'' squares

Chimneys

2- $1\frac{3}{4}'' \times 2''$ rectangles

Nine-Patches (dark/medium)

10-2'' squares

Background

1- $9\frac{1}{2}'' \times 3''$ rectangle

1- $9\frac{1}{2}'' \times 2\frac{1}{2}''$ rectangle

2- $3\frac{1}{2}''$ squares

2- $3\frac{1}{2}'' \times 2''$ rectangles

8-2'' squares

1-1'' x 2'' rectangle



Be My Neighbor

Block 12 is 9" x 18" finished.

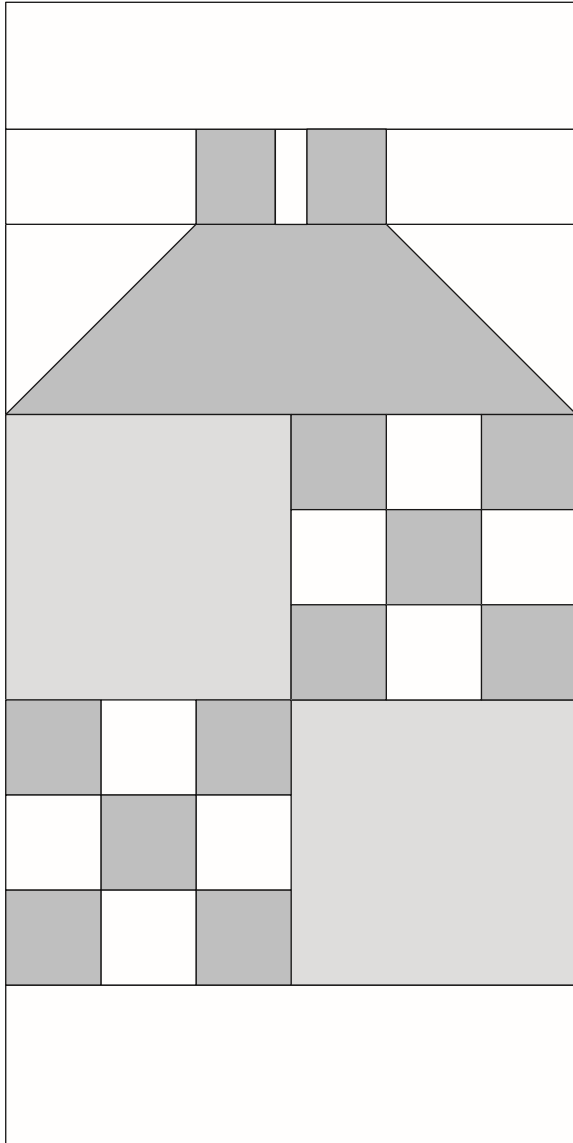

moda

Construction

Use ¼" seams. Press in the direction of the arrows in the diagrams.

1 Assemble the chimneys as shown.

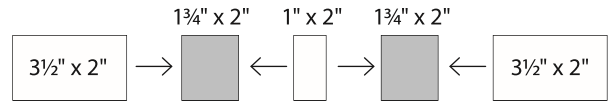

Chimneys
9½" x 2" unfinished
Make 1.

2 House Roof

Draw a diagonal line from corner to corner on the wrong side of 2–3½" background squares. Layer a 3½" marked background square, right sides together, on 1–9½" x 3½" roof rectangle as shown. Sew on the diagonal line. Trim ¼" from the sewn line. Press to reveal the triangle. Repeat on the the opposite end of the same rectangle. Make 1.

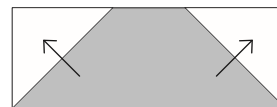
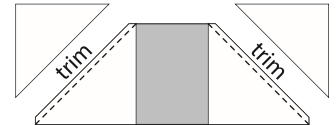
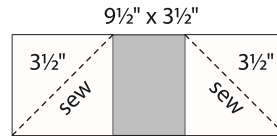

Roof
9½" x 3½" unfinished
Make 1.

3 Nine-Patch

Arrange 5–2" dark/medium squares and 4–2" background squares and 3 rows as shown. Join the rows. Make 2 nine-patches.

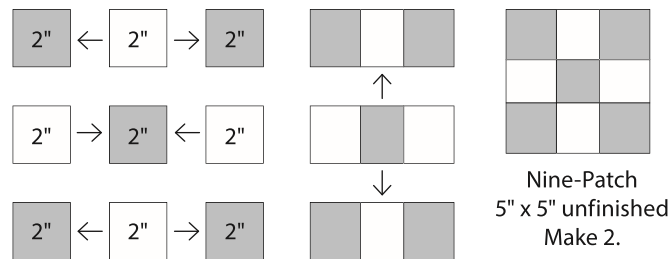

Nine-Patch
5" x 5" unfinished
Make 2.

4 Assemble the block as shown.

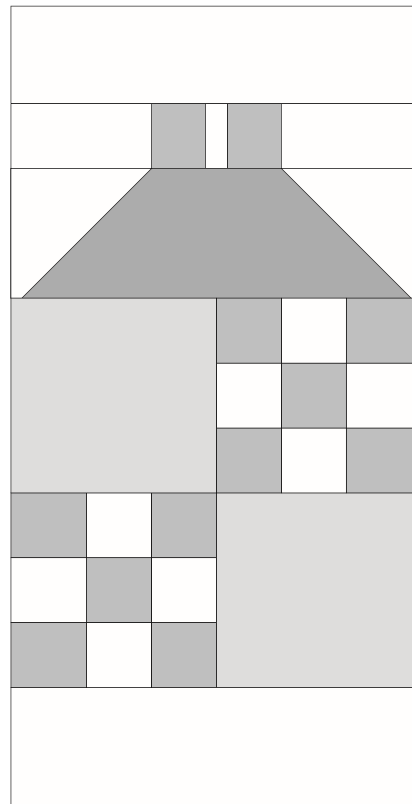
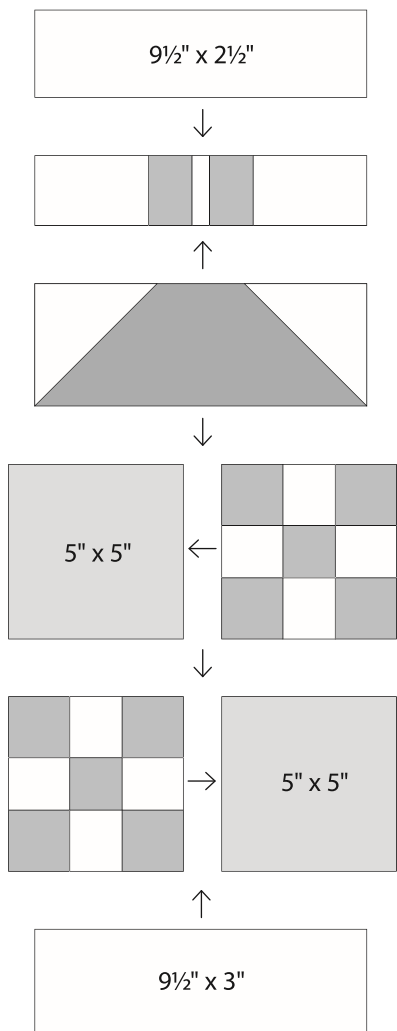

Block 12
 $9\frac{1}{2}'' \times 18\frac{1}{2}''$ unfinished

moda



moda

Be My Neighbor

Block 13

10½" x 18" finished

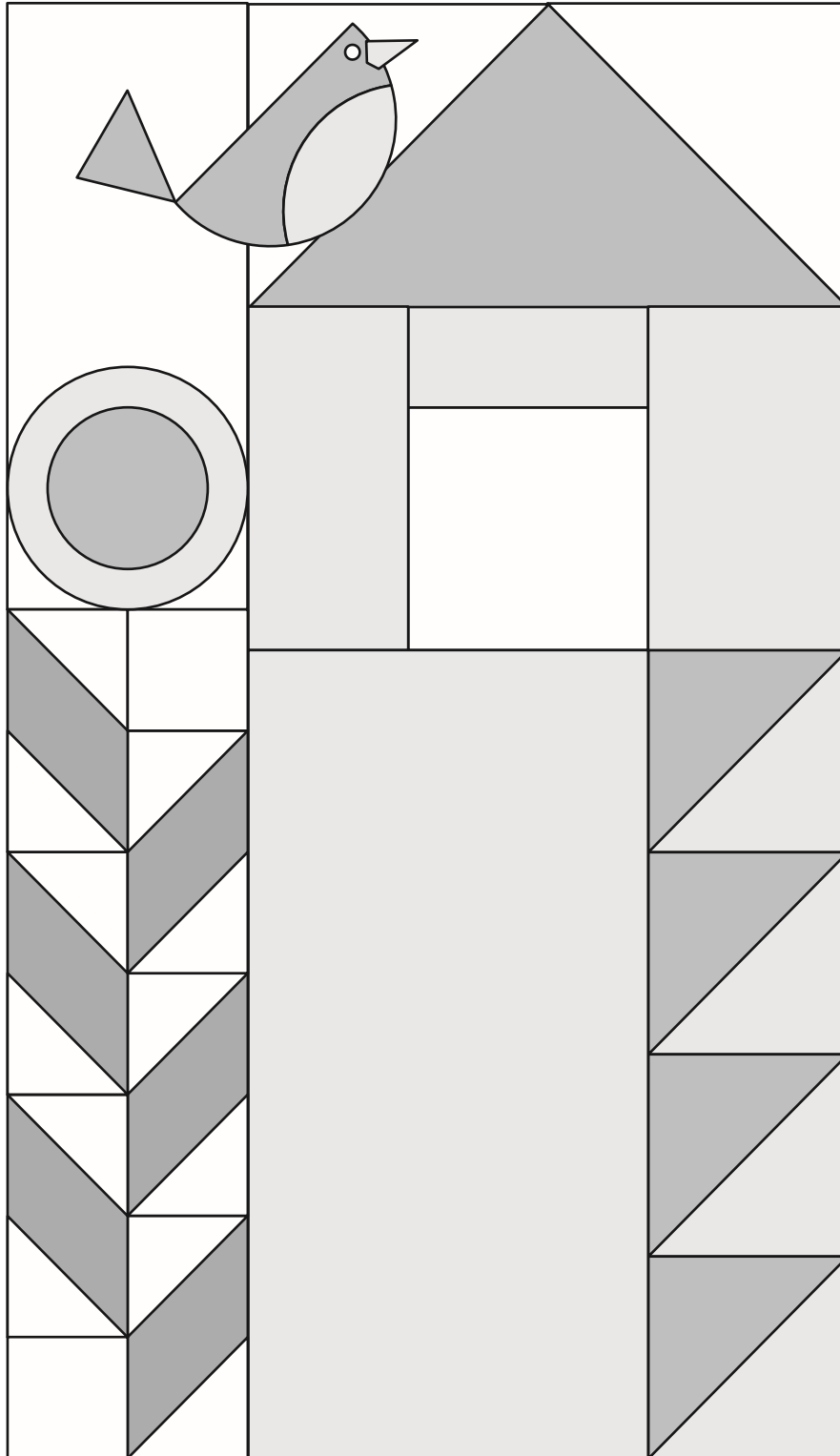

General Information

- These are very scrappy blocks. Mix your favorite Moda prints to create your colorful neighborhood!
- Share your progress and final quilt at #BeMyNeighbor. We love to see your results!!!

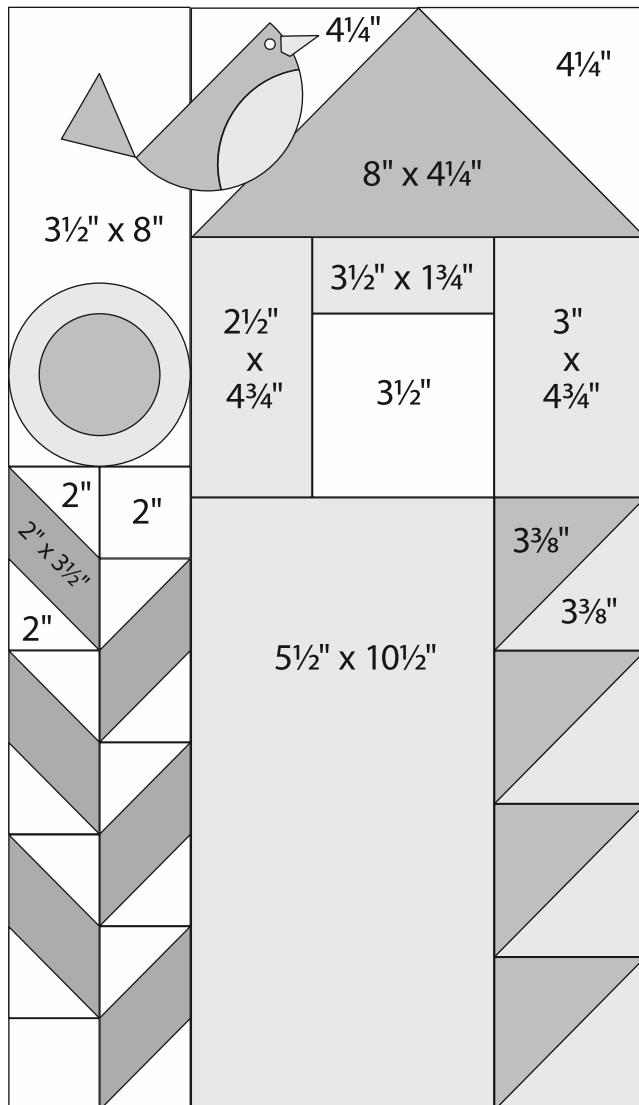

Block 13
11" x 18½" unfinished

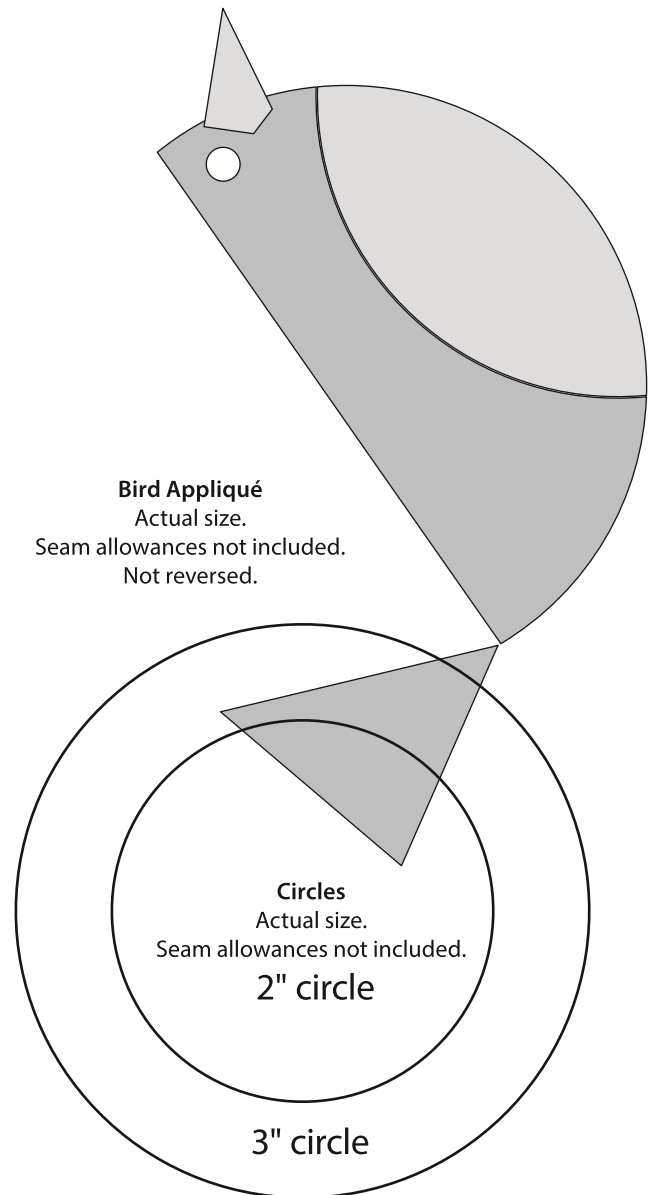

Cutting

Leaves 6–2" x 3½" rectangles	Roof 1–8" x 4¼" rectangle	House 1–5½" x 10½" rectangle 2–3⅜" squares; cut in half once on the diagonal to make 4 half-square triangles (HST)	Background 2–4¼" squares 14–2" squares 1–3½" x 8" rectangle
Flowers 2 circles	Half-Square Triangles 2–3⅜" squares; cut in half once on the diagonal to make 4 half-square triangles (HST)	1–3½" x 1¾" rectangle 1–3" x 4¾" rectangle 1–2½" x 4¾" rectangle	
Bird Appliqué 1–beak 1–body 1–tail 1–wing 1–eye	Window 1–3½" square		



Be My Neighbor

Block 13 is 10½" x 18" finished.

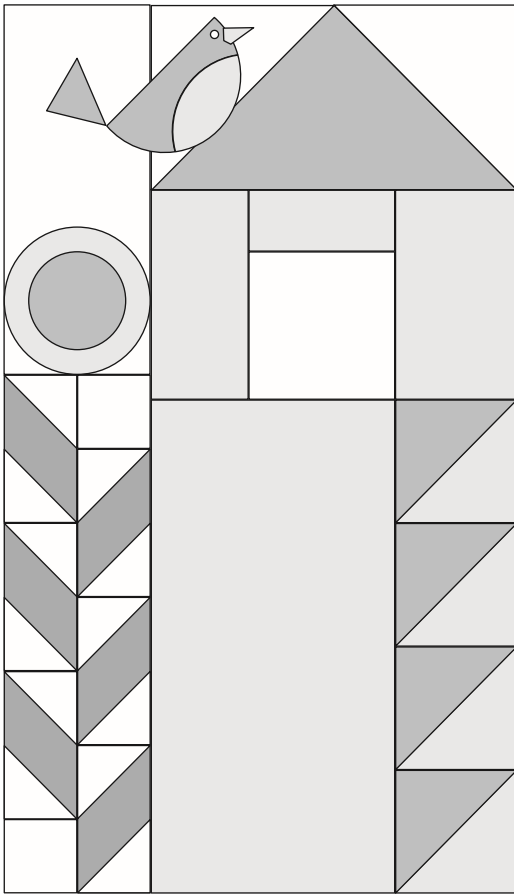

Construction

Use ¼" seams. Press in the direction of the arrows in the diagrams.

1 House Roof

Draw a diagonal line from corner to corner on the wrong side of 2–4¼" background squares. Layer a 4¼" marked background square, right sides together, on 1–8" x 4¼" roof rectangle as shown. Sew on the diagonal line. Trim ¼" from the sewn line. Press to reveal the triangle. Repeat on the opposite end of the same rectangle. Make 1.

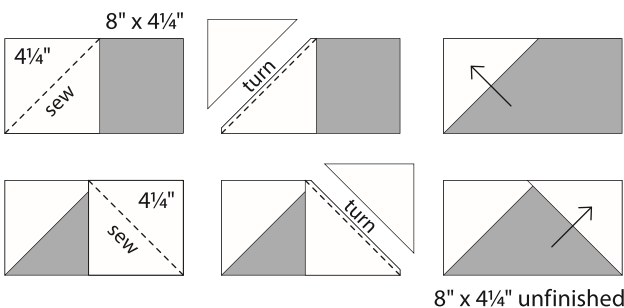

2 Flower

(A) Draw a diagonal line from corner to corner on the wrong side of 12–2" background squares. Layer a 2" marked background square, right sides together, on 1–2" x 3½" leaf rectangle as shown. Sew on the diagonal line. Trim ¼" from the sewn line. Press to reveal the triangle. Repeat on the opposite end of the same rectangle. Make 3 leaf As and 3 leaf Bs.

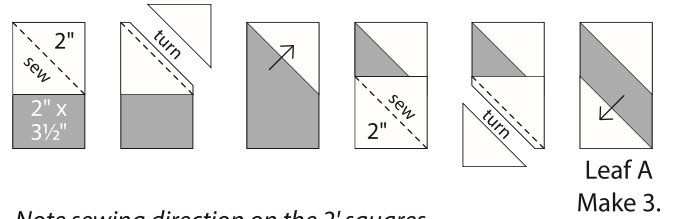

Note sewing direction on the 2" squares.

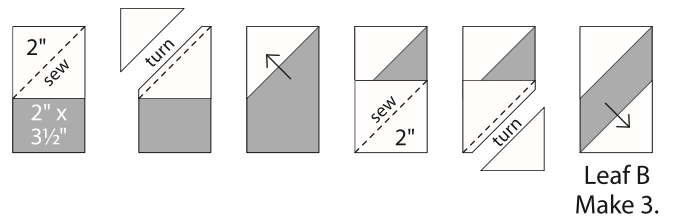

(B) Arrange and sew 3–Leaf As and 1–2" background square to make column A. Arrange sew 1–2" background square and sew 3–Leaf Bs to make column B. Join the columns, add a 3½" x 8" background rectangle. Use your appliqué method of choice to add the circles.

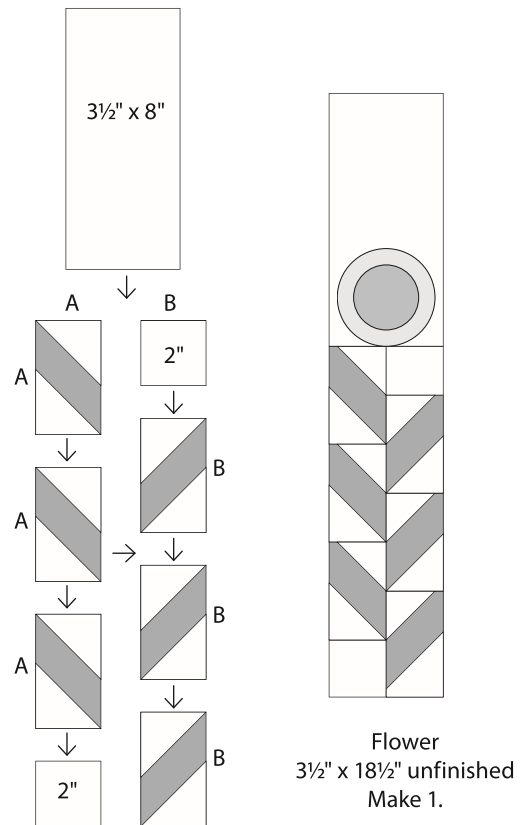

3 Join a $3\frac{3}{8}$ " dark HST and a $3\frac{3}{8}$ " house HST as shown. Make 4 half-triangle squares (HTS). Join the HTSs and a $5\frac{1}{2}$ " x $10\frac{1}{2}$ " house rectangle as shown.

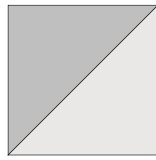
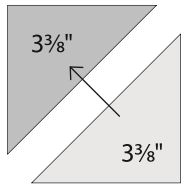

HTSs
3" x 3"
unfinished
Make 4.

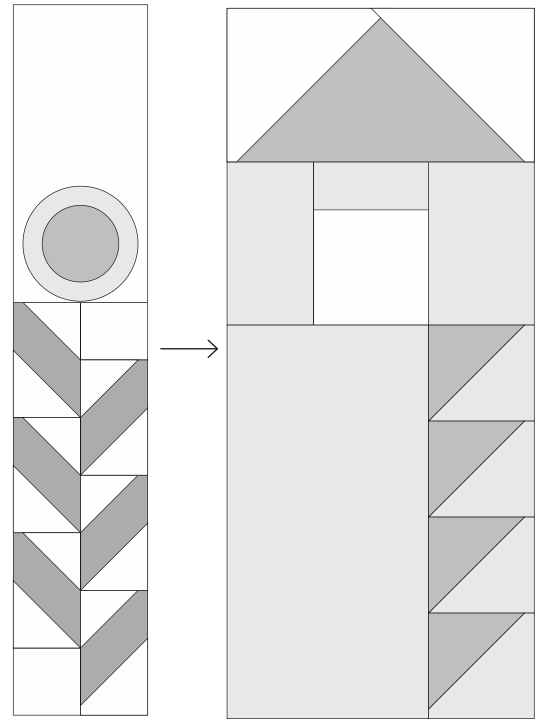
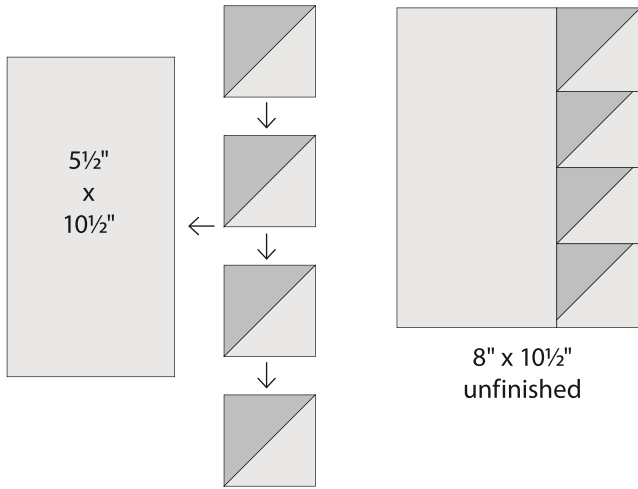

moda

4 Assemble the house as shown. Use fusible web and a zig zag or blanket stitch to add the bird to the completed house block.

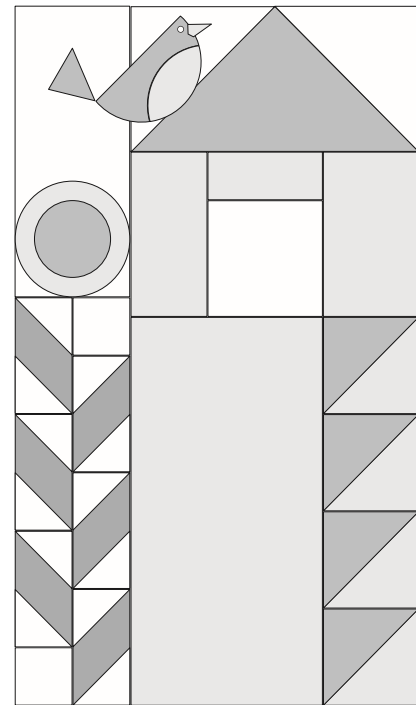
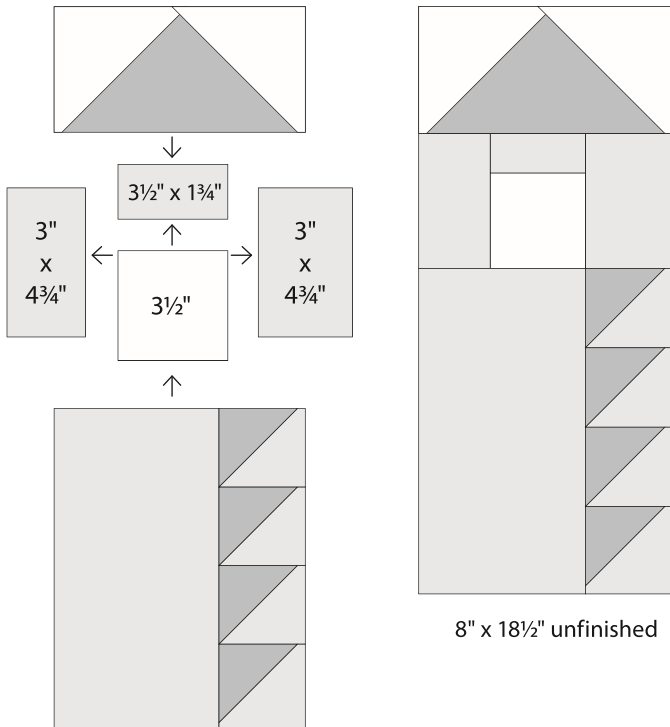

Block 13
11" x 18½" unfinished



moda

Be My Neighbor

Block 14

12" x 18" finished

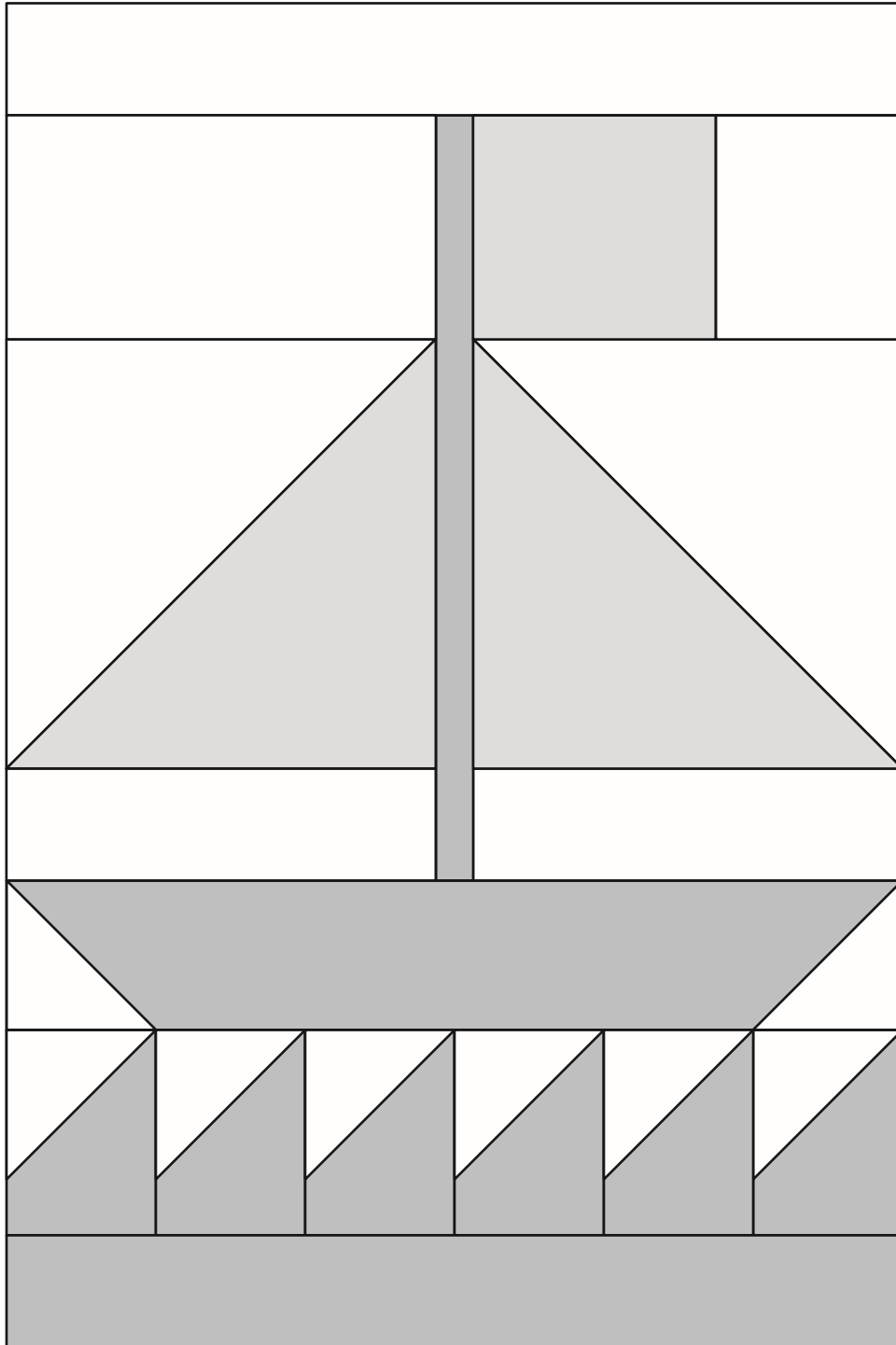

General Information

- These are very scrappy blocks. Mix your favorite Moda prints to create your colorful neighborhood!
- Share your progress and final quilt at #BeMyNeighbor. We love to see your results!!!

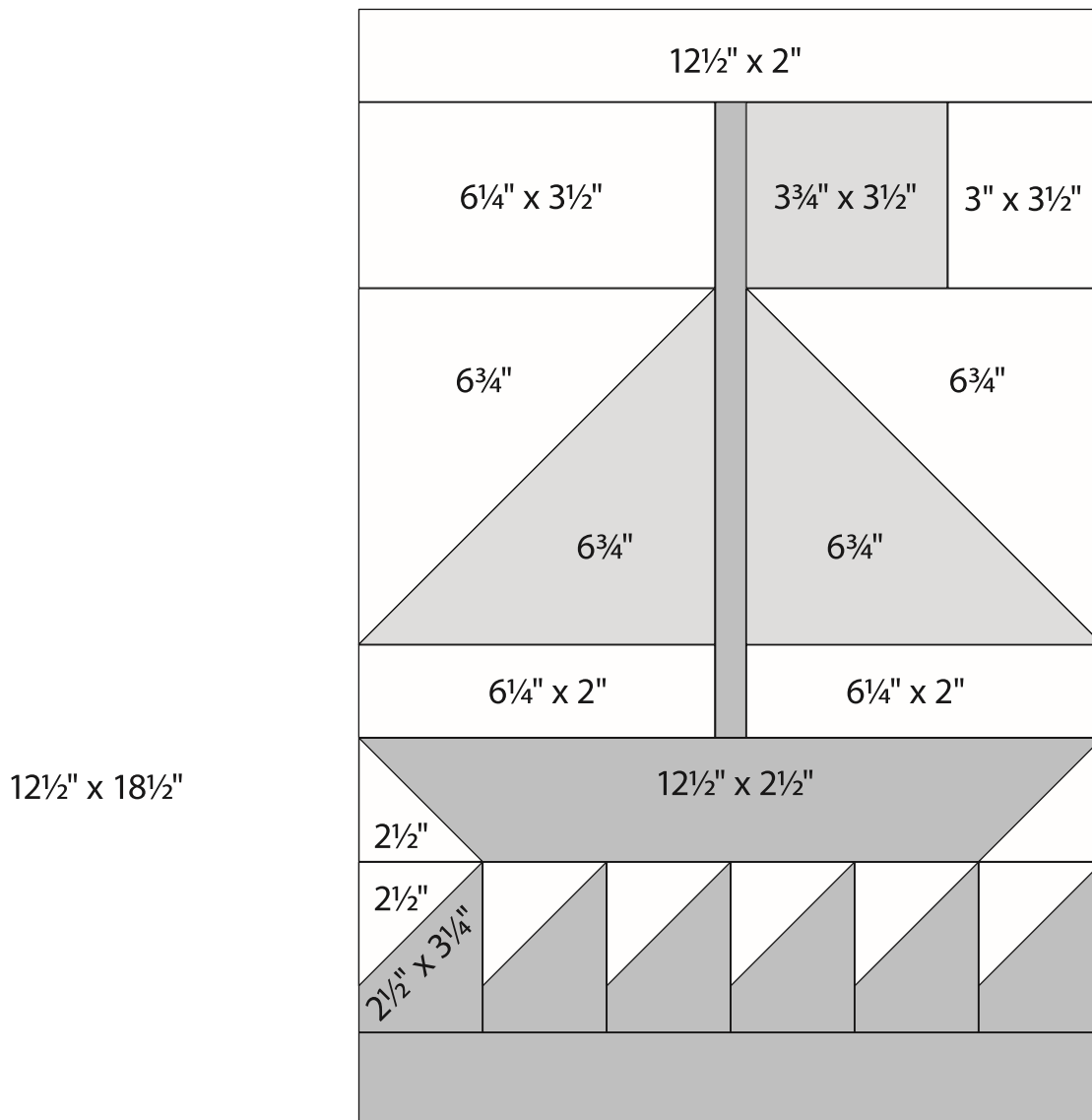

Block 14
12 1/2" x 18 1/2" unfinished

Cutting

<p>Flag 1-3 3/4" x 3 1/2" rectangle</p>	<p>Boat 1-12 1/2" x 2 1/2" rectangle</p>	<p>Background 1-12 1/2" x 2" rectangle 1-6 3/4" square cut in half once on the diagonal to make 2 half-square triangles 1-6 1/4" x 3 1/2" rectangles 2-6 1/4" x 2" rectangles 1-3" x 3 1/2" rectangle 8-2 1/2" squares</p>
<p>Sails 1-6 3/4" square cut in half once on the diagonal to make 2 half-square triangles</p>	<p>Waves and Water 6-2 1/2" x 3 1/4" rectangles 1-12 1/2" x 2" rectangle</p>	
<p>Mast 1-1" x 10 3/4" rectangle</p>		



moda Be My Neighbor

Block 14 is 12" x 18" finished.

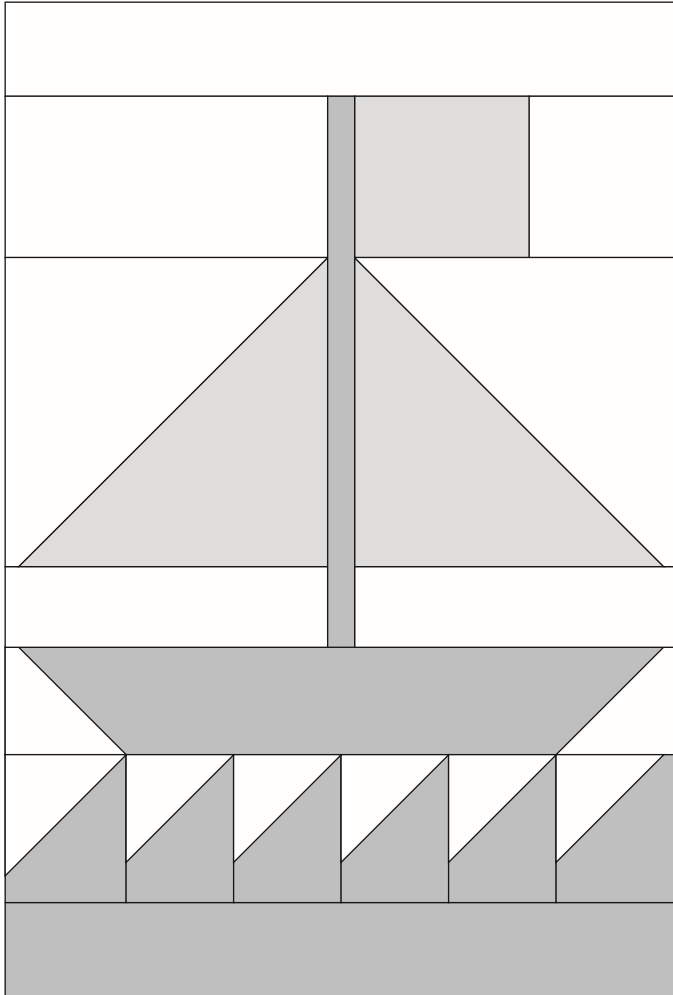

moda

Construction

Use $\frac{1}{4}$ " seams. Press in the direction of the arrows in the diagrams.

- 1 Sails**
Join 1- $6\frac{3}{4}$ " sail half-square triangle and 1- $6\frac{3}{4}$ " background half-square triangle as shown. Make 2.

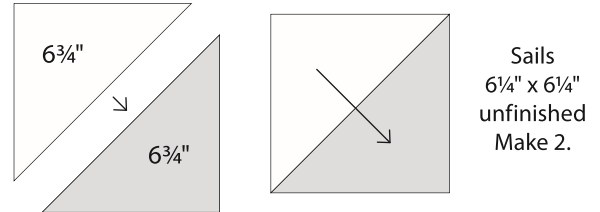

- 2 Boat**
Draw a diagonal line from corner to corner on the wrong side of 2- $2\frac{1}{2}$ " background squares. Layer a $2\frac{1}{2}$ " marked background square, right sides to together, on 1- $12\frac{1}{2}$ " x $2\frac{1}{2}$ " boat rectangle as shown. Sew on the diagonal line. Trim $\frac{1}{4}$ " from the sewn line. Press to reveal the triangle. Repeat on the the opposite end of the same rectangle.

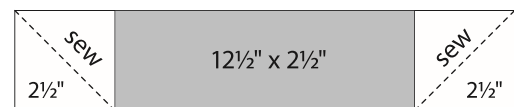

Boat $2\frac{1}{2}$ " x $12\frac{1}{2}$ " unfinished

3 Waves

Draw a diagonal line from corner to corner on the wrong side of 6-2½" background squares. Layer a 2½" marked background square, right sides to together, on 1-2½" x 3¼" wave rectangle as shown. Sew on the diagonal line. Trim ¼" from the sewn line. Press to reveal the triangle. Join the 6 waves.

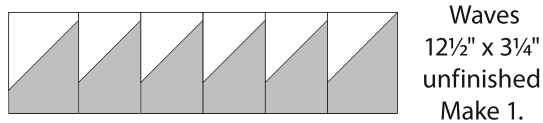
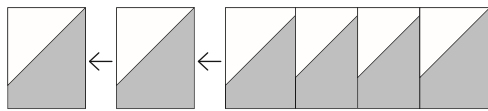
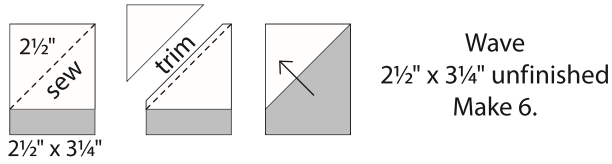

4 Assemble flag and sail.

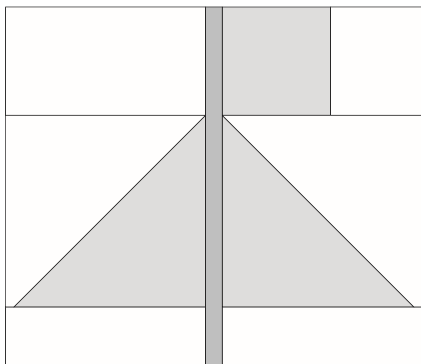
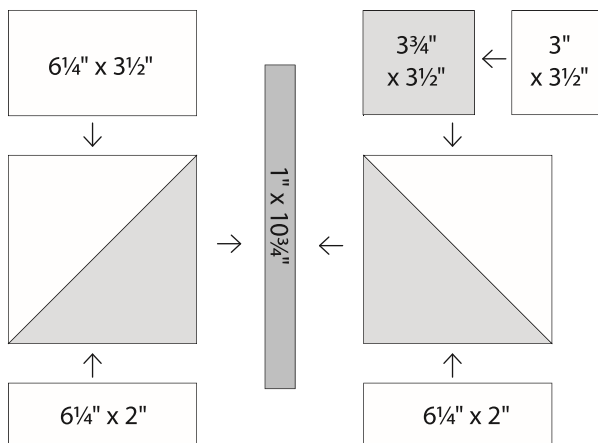

Flag and Sail
12½" x 10¾" unfinished

5 Assemble the block as shown.

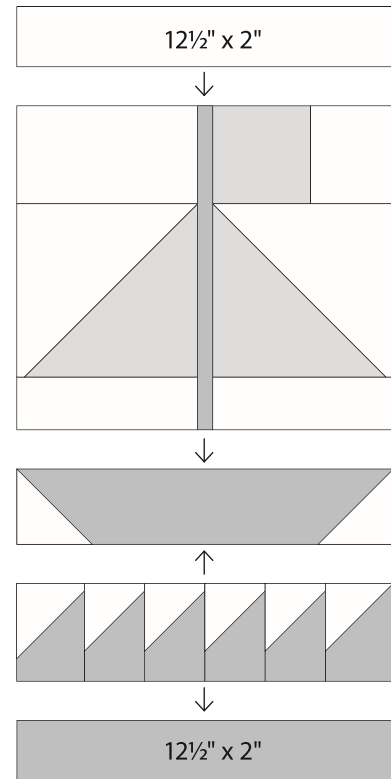

moda

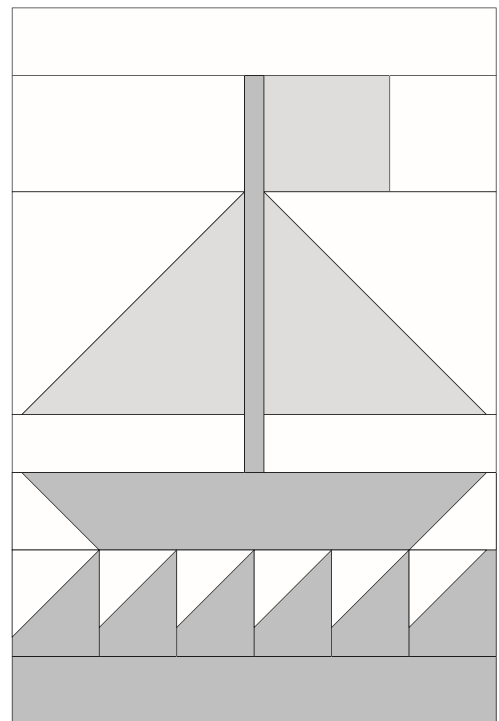

Block 14
12½" x 18½" unfinished